

The State of Unclassified and Commercial Technology Capable of Some Electronic Mind Control Effects

Eleanor White, P.Eng.

April 4, 2000

<http://www.raven1.net/uncom.htm> ..or.. <http://www.bestnet.org/~raven1/uncom.htm>

To help the reader appreciate the importance of this matter..

"We need a program of psychosurgery and political control of our society. The purpose is physical control of the mind. Everyone who deviates from the given norm can be surgically mutilated.

"The individual may think that the most important reality is his own existence, but this is only his personal point of view. This lacks historical perspective.

"Man does not have the right to develop his own mind. This kind of liberal orientation has great appeal. We must electrically control the brain. Some day armies and generals will be controlled by electrical stimulation of the brain."

Dr. Jose Delgado (MKULTRA experimenter who demonstrated a radio- controlled bull on CNN in 1985)

Director of Neuropsychiatry, Yale University Medical School

Congressional Record No. 26, Vol. 118, February 24, 1974

Monkeys in restraint, wires coming out of top of skull, left image "normal", right image with electric current being fed into the monkey's brain - note pupil sizes and clenched teeth! These images portray Dr. Delgado's ruthless disregard for life, pain, and suffering!



=====

CONTENTS

This document is organized so that a narrative article appears at the top, followed by appendices.

- BLACK = NARRATIVE ARTICLE
- BLUE = APPENDICES

<u>I. LIMITATIONS</u>	3
<u>II. INTRODUCTION</u>	3
<u>III. MIND CONTROL EFFECTS</u>	4
<u>IV. MAJOR TECHNOLOGY CLASSES</u>	9
<u>V. PULSED MICROWAVE</u>	12
<u>VI. ULTRASOUND AND VOICE-FM</u>	15
<u>VII. THROUGH-WALL RADAR</u>	19
<u>VIII. THOUGHT READING</u>	21
<u>IX. IMPLANTS</u>	23
<u>X. CONCLUSION</u>	25
<u>XI. APPENDICES</u>	27
<u>PM1.....THE LIDA MACHINE</u>	28
<u>PM2.....DR. ALLAN FREY'S PAPER</u>	32
<u>PM3.....NASA ARTICLE</u>	43
<u>PM4.....SCIENCE & ENGINEERING ASSOCIATES/KOHN'S PROJECTS</u>	46
<u>PM5.....BIOLOGICAL AMPLIFICATION (OF EM SIGNALS)</u>	48
<u>PM6.....DR. DON R. JUSTESEN'S REPORT: 1974 VOICE TO SKULL SUCCESS</u>	52
<u>PM7.....U.S. GOVT DOCUMENT RE: RUSSIAN MIND CONTROL</u>	54
<u>PM8.....OAK RIDGE LABS AND OTHER BULLETINS</u>	58

[US4....SILENT HYPNOSIS, VOICE-FM COMMERCIAL METHOD..... 88](#)

[US5...."ACOUSTIC SPOTLIGHT", CAN TARGET ONE PERSON IN CROWD..... 92](#)

[TWR1...THE LADS DEVICE..... 100](#)

[TWR2...THE RADAR FLASHLIGHT..... 102](#)

[TWR3...MILLIVISION THRU-CLOTHING/WALL RADAR..... 103](#)

[TWR4...GROUND \[**OR HOME/APT WALL**\] PENETRATING RADAR..... 104](#)

[TR1....COMMERCIALLY AVAILABLE THOUGHT-READING DEVICES..... 108](#)

[TR2....IMPLANTED RATS CAN CONTROL DEVICES WITH THOUGHT..... 112](#)

[TR3....THOUGHT READING BY RADIO SIGNAL..... 114](#)

[TR4....ELECTRONICS SEES WHAT A CAT SEES..... 117](#)

[TR5....MIND SWITCH - THINK APPLIANCES ON, OFF, OR ADJUST..... 120](#)

[IMP1....PROMOTION OF HUMAN IMPLANTATION BY NIH..... 123](#)

[IMP2....ITALIAN DOCTOR REPORTS HUMAN IMPLANTATION..... 126](#)

[IMP3...IMPLANT TRANSMITS PHYSIO- AND PSYCHO- PARAMETERS BY RADIO..... 127](#)

[IMP4....DR JOSE DELGADO'S "STIMOCEIVER"/HUMAN IMPLANT EXPERIMENTS..... 130](#)

[IMP5....UNCLASSIFIED SATELLITE TRACKING HUMAN IMPLANT SYSTEM..... 134](#)

[PS.....POSTSCRIPT..... 136](#)

[PRINT FROM separate pages](#) for unbroken sections and images

**** BE SURE "IMAGES" ARE ON TO ALLOW PRINTING OF IMAGES ****

=====

I. LIMITATIONS

The author acknowledges that this article falls short of a rigorous academic paper. This is explained by the fact that all involuntary neuro-electromagnetic experimentees are kept in a sort of "barely alive" condition, with significant health problems, and either unable

Furthermore, since the perpetrators constantly work to prevent the public from knowing anything about electronic mind control, evidence is obtainable with great difficulty, and often the only evidence is of lower quality than would be accepted for a scientific treatise.

In short, everything in this article represents a struggle against immense odds. We ask readers to understand this and hope that those who are not under electronic attack and surveillance will try through independent channels to find better quality proof.

[Up to Contents](#)

=====

II. INTRODUCTION

Electronic mind control technology had it's start in the 1950s, as an obscure branch of the CIA's MKULTRA project group. Just as organized crime is not stopped by hearings and court cases, neither did this originally obscure branch of MKULTRA activity, when the institutional/drug/child abuse phases were exposed by the U.S. Senate's Church-Inouye hearings in the late 1970s. No criminal proceedings followed, and only two civil law suits (Orlikow and Bonacci) have succeeded.

This assembly of unclassified and commercial literature is to show investigators and concerned citizens that in spite of the tightest possible information blackout imposed in the early 1970s, enough of the classified mind control technology has leaked out to show that significant classified accomplishments are overwhelmingly likely, and in need of disclosure, here at the end of the 20th century.

understand the implications of continued turning the other way.

[Up to Contents](#)

=====

III. MIND CONTROL EFFECTS

Since government-backed electronic mind control is classified at the highest levels in all technologically capable governments, the description of effects is taken from the personal experiences of over 300 known involuntary experimentees. The experimentees without exception report that once the "testing" begins, the classified experiment specification apparently requires that the "testing" be continued for life. Many are young seniors, some in their 70s and 80s.

Some have children and the children are often subjected to the same "testing" as their parent(s).

The effects pattern:

This article is about unclassified/commercial technologies which can produce some of the effects of the classified equipment, not testimonials, but this much has become clear over time:

- All "testing" consists of unique, carefully engineered-unprovable events to produce psychological stress in the victim. There are no events which do not fit that apparent purpose.
 - In every series of stress event type, ONE introductory event of very high energy/effect is staged. The obvious purpose is to be certain the victim KNOWS this is external harassment, and not just
-

initial "introductory" event.

- This type of testing started during the Cold War, and shows every characteristic of being for military and intelligence psychological warfare purposes.
- This type of testing all points to CONTROL of the test subject. Endlessly repeated words generated inescapably within the skull are just one hypnosis-like experience.
- Given that CONTROL is the likely ultimate purpose, INVOLUNTARY test subjects become a necessity. Thus, the phenomenon of people apparently being chosen at random for this "work".
- Given a requirement for INVOLUNTARY test subjects, the ONLY group with the necessary funds and legal powers is GOVERNMENT. Private contractors are no doubt the main perpetrators to keep the "work" well covered, but without secret complicity of GOVERNMENT, this expensive, extensive, and illegal atrocity simply could not happen.

The effect types categorized:

Here is a list of most of the common effects. It is not exhaustive, but is intended to show the reader how the perpetrators' palette of stress effects is broken down. Indent levels are used to show categories and sub-categories:

1. Invasive At-a-Distance Body Effects (including mind)
 - a. Sleep deprivation and fatigue
 - i. Silent but instantaneous application of "electronic caffeine" signal, forces awake and keeps awake
 - ii. Loud noise from neighbours, usually synchronized
-

- iv. Daytime "fatigue attacks", can force the victim to sleep
and/or weaken the muscles to the point of collapse
 - b. Audible Voice to Skull (V2S)
 - i. Delivered by apparent at a distance radio signal
 - ii. Made to appear as emanating from thin air
 - iii. Voices or sound effects only the victim can hear
 - c. Inaudible Voice to Skull (Silent Sound)
 - i. Delivered by apparent at a distance radio signal;
manifested by sudden urges to do something/go somewhere
you would not otherwise want to; silent (ultrasonic)
hypnosis presumed
 - ii. Programming hypnotic "triggers" - i.e. specific phrases
or other cues which cause specific involuntary actions
 - d. Violent muscle triggering (flailing of limbs)
 - i. Leg or arm jerks to violently force awake and keep awake
 - ii. Whole body jerks, as if body had been hit by large jolt
of electricity
 - iii. Violent shaking of body; seemingly as if on a vibrating
surface but where surface is in reality not vibrating
 - e. Precision manipulation of body parts (slow, specific purpose)
 - i. Manipulation of hands, forced to synchronize with closed-eyes
but FULLY AWAKE vision of previous day; very powerful and
coercive, not a dream
 - ii. Slow bending almost 90 degrees BACKWARDS of one toe at a
time or one finger at a time
 - iii. Direct at-a-distance control of breathing and vocal cords;
including involuntary speech
 - iv. Spot blanking of memory, long and short term
 - f. Reading said-silently-to-self thoughts
-

- ii. Real time reading subvocalized words, as while the victim reads a book, and BROADCASTING those words to nearby people who form an amazed audience around the victim
 - g. Direct application of pain to body parts
 - i. Hot-needles-deep-in-flesh sensation
 - ii. Electric shocks (no wires whatsoever applied)
 - iii. Powerful and unquenchable itching, often applied precisely when victim attempts to do something to expose this "work"
 - iv. "Artificial fever", sudden, no illness present
 - v. Sudden racing heartbeat, relaxed situation
 - h. Surveillance and tracking
 - i. Thru wall radar and rapping under your feet as you move about your apartment, on ceiling of apartment below
 - ii. Thru wall radar used to monitor starting and stopping of your urination - water below turned on and off in sync with your urine stream
 - iii. Loud, raucous artificial bird calls everywhere the victim goes, even into the wilderness
2. Invasive Physical Effects at a Distance, non-body
- a. Stoppage of power to appliances (temporary, breaker ON)
 - b. Manipulation of appliance settings
 - c. Temporary failures that "fix themselves"
 - d. Flinging of objects, including non-metallic
 - e. Precision manipulation of switches and controls
 - f. Forced, obviously premature failure of appliance or parts
-

close friends and family members in harassment

i. Rudeness for no cause

ii. Tradesmen always have "problems", block your car, etc.

iii. Purchases delayed, spoiled, or lost at a high rate

iv. Unusually loud music, noise, far beyond normal

b. Break-ins/sabotage at home

i. Shredding of clothing

ii. Destruction of furniture

iii. Petty theft

iv. Engineered failures of utilities

c. Sabotage at work

i. Repetitive damage to furniture

ii. Deletion/corruption of computer files

iii. Planting viruses which could not have come from

your computer usage pattern

iv. Delivered goods delayed, spoiled, or lost at a high rate

v. Spreading of rumors, sabotage to your working reputation

vi. Direct sabotage and theft of completed work; tradesmen

often involved and showing obvious pleasure

FORCED MEMORY BLANKING AND INDUCED ERRONEOUS ACTIONS

INDUCED CHANGES TO HEARING - BOTH APPARENT DIRECTION AND VOLUME, AND SOMETIMES EVEN CONTENT

SUDDEN, VIOLENT ITCHING INSIDE EYELIDS

FORCED MANIPULATION OF AIRWAYS, INCLUDING THE GENERATION OF CLEAR, FORCED SPEECH

WILDLY RACING HEART WITHOUT CAUSE

REMOTEY INDUCED VIOLENT NO-RASH ITCHING, WITH PREFERENCE FOR HARD-TO-REACH AREAS, OFTEN DURING DELICATE OR MESSY WORK

FORCED NUDGING OF ARM DURING DELICATE OR MESSY WORK, CAUSING INJURY OR SPILLS

SPECIAL ATTENTION TO GENITAL AREA: ITCHING, FORCED ORGASM, INTENSE PAIN

INTENSE GENERAL PAIN, OR HOT-NEEDLES-PUSHED-DEEP-INTO-FLESH SENSATIONS.

ALSO - WILD FLAILING, SOMETIMES FOLLOWED BY SHORT PERIODS OF "RIGOR MORTIS"

HARD-TO-REACH ITCH SITE, TOP AND BOTTOM, NEVER ANY RASH

"DEMO" NEURO-CONTROL BY BENDING EACH TOE BACKWARDS ALMOST 90 DEGREES, ONE AT A TIME, OVER A COUPLE OF MINUTES

READING AND BROADCASTING THOUGHTS

CONTROLLED DREAMS

FORCED WAKING VISIONS SOME SYNC'ED WITH BODY MOTION

MICROWAVE HEARING *

"TRANSPARENT EYELIDS"

ARTIFICIAL TINNITUS

FORCED MOVEMENT OF JAW AND CLACKING OF TEETH

FORCED "MUSCLE QUAKING" OF THE LARGE MUSCLES ON THE BACK - AFFECTS SHADED AREA

FORCED PRECISION MANIPULATION OF HANDS, SOMETIMES SYNC'ED TO THE FORCED WAKING VISIONS

*** THE FIRST UN-CLASSIFIED SUCCESSFUL TRANSMISSION OF THE HUMAN VOICE DIRECTLY INTO THE SKULL OF A LIVING PERSON WAS PERFORMED BY DR. JOSEPH C. SHARP, OF THE WALTER REED ARMY INSTITUTE OF RESEARCH IN 1974.**

BY CONVERTING A HYPNOTIST'S VOICE INTO THE ULTRASOUND RANGE USING A MODIFIED TELEPHONE VOICE CHANGER, IT IS POSSIBLE TO HYPNOTIZE A TARGET WITHOUT THE TARGET BEING AWARE, FROM HIDING, LEAVING ZERO TRACE EVIDENCE.

GENERAL EFFECTS: SUDDEN OVERHEATING, ALL-BODY PAIN, FORCED "CAFFEINE FIELD" SLEEP PREVENTION, FORCED "DROP-IN-YOUR-TRACKS" SLEEP INDUCEMENT, IRRESISTIBLE "GO HERE, GO THERE" COMMANDS, MICROWAVE BURNS, ELECTRIC SHOCKS

NEURO-ELECTROMAGNETIC WEAPON EFFECTS

<http://www.raven1.net/effects.gif> ...or... <http://www.bestnet.org/~raven1/effects.gif> Jan 19/00

Illustration of the bodily effects

These technology classes are for the UNclassified and commercial equipment which can emulate the "real" classified mind control equipment. Effect section 2, "Invasive Physical Effects at-a-Distance", clearly establishes the existence of remote precision manipulation of objects which is far beyond the capabilities of unclassified and commercial equipment at the time of writing.

REMOTE PHYSICAL MANIPULATION is not covered in this article, but the reader should know that both NASA and IEEE have noted successes in creating very small antigravity effects (which are not due to simple magnetism.)

TRANSMISSION METHODS FOR NEURO-EFFECTIVE SIGNALS:

- pulsed microwave (i.e. like radar signals)
- ultrasound and voice-FM (transmitted through the air)

While transmission of speech, dating from the early 1970s, was the first use of pulsed microwave, neuro-effective signals can now cause many other nerve groups to become remotely actuated. At time of writing, that technology appears to be classified.

PAVLOVIAN HYPNOTIC TRIGGERS:

A [Pavlovian] hypnotic trigger is a phrase or any other sensory cue which the victim is programmed to involuntarily act on in a certain way. The 50s-70s MKULTRA survivors can still be triggered from programming done decades ago. A name

One of the main goals of the institutional/drug/child abuse phases of the CIA MKULTRA atrocities (1950's through 1970's) was to implant triggers using a "twilight state" (half-conscious) medication and tape recorded hypnosis. The ultimate goal was to have the acting out of Pavlovian triggers erased from the victim's memory.

Using one of the two transmission methods above, these triggers are now planted using either of the above two transmission methods, but with the words moved up just above (or near the top of) the audible frequency range. The result is that hypnotic triggers are planted without the subject being aware. This technology was used in the Gulf War and has a name: "Silent Sound"

THROUGH-WALL SURVEILLANCE METHODS:

So-called "millimeter wave" scanning. This method uses the very top end of the microwave radio signal spectrum just below infra-red. To view small objects or people clearly, the highest frequency that will penetrate non-conductive or poorly- conductive walls is used. Millimeter wave scanning radar can be used in two modes:

- passive (no signal radiated, uses background radiation already in the area to be scanned, totally UNdetectable)
 - active (low power millimeter wave "flashlight" attached to the scanner just as a conventional
-

THOUGHT READING:

Thought reading can be classed as a "through wall surveillance" technology. Thought reading, in the unclassified/commercial realm, can be broken down as follows:

- thru-skull microwave reading
- magnetic skull-proximity reading

BRAIN ENTRAINMENT:

The reverse of biofeedback. Those low frequency electrical brain rhythms which are characteristics of various moods and states of sleep can not only be read out using biofeedback equipment or EEG machines, but using radio, sound, contact electrodes, or flashing lights, the moods and sleep states can be generated or at least encouraged using brain entrainment devices.

Brain entrainment signals cannot carry voice, which is a much higher frequency range. Brain entrainment can, however, be used to "set up" a target to make him/her more susceptible to hypnosis.

These major technology classes can produce some of the observed mind control effects, FROM HIDING AND UNDETECTABLY, with the exception of remote physical manipulation.

Diagram showing the overall method, based entirely on unclassified 1974 technology, of how SILENT hypnosis may be transmitted to a target without the target's being aware. This technique is probably the most insidious, because it allows months and years of programming and Pavlovian trigger-setting, while the target cannot resist.

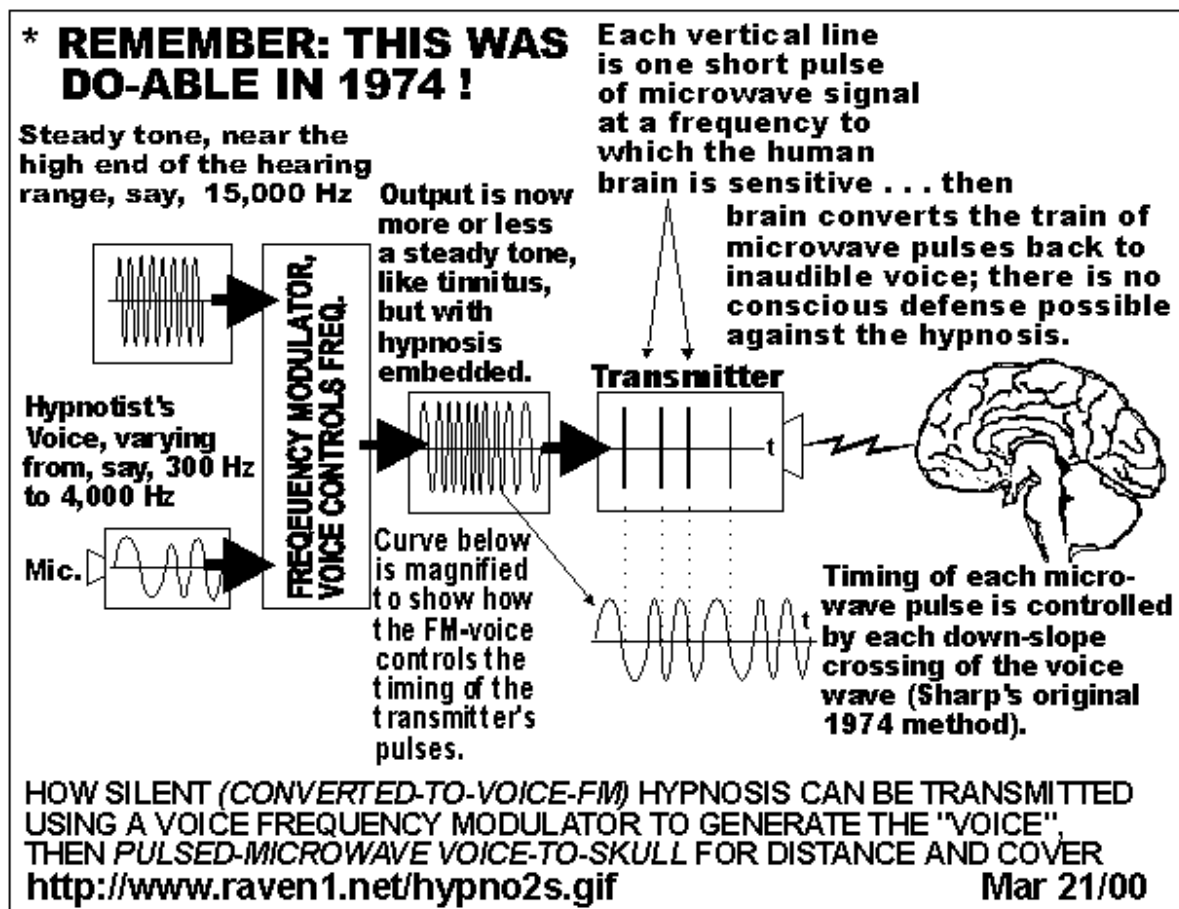

[Up to Contents](#)

V. PULSED MICROWAVE

equipment they were working on. This phenomenon has been studied extensively by Dr. Allan Frey, whose work has been published in a number of reference books.

What Dr. Frey found was that single pulses of microwave could be heard by some people as "pops" or "clicks", while a train of uniform pulses could be heard as a buzz, without benefit of any type of receiver.

Dr. Frey also found that a wide range of frequencies, as low as 125 MHz (well below microwave) worked for some combination of pulse power and pulse width. Detailed unclassified studies mapped out those frequencies and pulse characteristics which are optimum for generation of "microwave hearing".

Very significantly, when discussing electronic mind control, is the fact that the PEAK PULSE POWER required is modest - something like 0.3 watts per square centimeter of skull surface, and this power level is only applied for a very small percentage of each pulse's cycle time. 0.3 watts/sq cm is about what you get under a 250 watt heat lamp at a distance of one meter. It is not a lot of power.

When you take into account that the pulse train is OFF (no signal) for most of each cycle, the average power is so low as to be nearly undetectable.

Frequencies that act as voice-to-skull carriers are not single frequencies, as, for example TV or cell phone channels are. Each sensitive frequency is actually a range or "band" of frequencies. A technology used to reduce both interference and detection is called "spread

Unless a receiver "knows" the hop schedule in advance, there is virtually no chance of receiving or detecting a coherent readable signal. Spectrum analyzers, used for detection, are receivers with a screen. A spread spectrum signal received on a spectrum analyzer appears as just more "static" or noise.

My organization was delighted to find the actual method of the first successful UNclassified voice to skull experiment in 1974, by Dr. Joseph C. Sharp, then at the Walter Reed Army Institute of Research.

Dr. Sharp's basic method is shown in Appendix PM6, below. A Frey-type audible pulse was transmitted every time the voice waveform passed down through the zero axis, a technique easily duplicated by ham radio operators who build their own equipment.

A pattern seems to be repeated where research which could be used for mind control starts working, the UNclassified researchers lose funding, and in some cases their notes have been confiscated, and no further information on that research track is heard in the unclassified press.

Pulsed microwave voice-to-skull research is one such track.

ORDINARY RADIO AND TV SIGNALS USE A SMOOTH WAVE FORM CALLED A 'SINE' WAVE, SHOWN BELOW. THIS SMOOTH SINE WAVE SIGNAL CANNOT NORMALLY PENETRATE THE 'VOLTAGE GRADIENT' ACROSS NERVE CELL WALLS

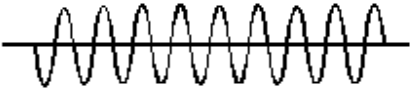

RADAR SIGNALS CONSIST OF VERY SHORT AND POWERFUL PULSES OF SINE WAVE SIGNAL,



... AND THESE SHORT PULSES CAN PENETRATE THE STEEP VOLTAGE GRADIENT ACROSS NERVE CELL WALLS. THIS WAS MADE PUBLIC BY G.E. SCIENTIST ALLAN H. FREY AT CORNELL UNIVERSITY IN 1962.

NASA, DOD, AND EPA HAVE PUBLISHED REPORTS WHICH DECLARE THAT WORD COMMUNICATION BY THIS METHOD IS AN ESTABLISHED TECHNOLOGY.

DIFFERENCES IN OSMOSIS OF IONS (DISSOLVED SALT COMPONENTS) CAUSE A SMALL VOLTAGE DIFFERENCE ACROSS CELL WALLS

WHEN A SMALL VOLTAGE APPEARS ACROSS A VERY TINY DISTANCE, THE CHANGE IN VOLTAGE IS CALLED VERY 'STEEP', AND THIS STEEP 'GRADIENT' IS WHAT KEEPS NORMAL RADIO SIGNALS FROM THROWING US INTO CONVULSIONS.

*THE FIRST UN-CLASSIFIED SUCCESSFUL TRANSMISSION OF THE HUMAN VOICE DIRECTLY INTO THE SKULL OF A LIVING PERSON WAS PERFORMED BY DR. JOSEPH C. SHARP OF THE WALTER REED ARMY INSTITUTE OF RESEARCH IN **1974**.

BY CONVERTING A HYPNOTIST'S VOICE INTO THE ULTRASOUND RANGE USING A MODIFIED TELEPHONE VOICE CHANGER, IT IS POSSIBLE TO HYPNOTIZE A TARGET WITHOUT THE TARGET BEING AWARE, FROM HIDING, LEAVING ZERO TRACE EVIDENCE.

SECTION OF CELL WALL

DIFFERENT IONS PASS THRU CELL WALL AT DIFFERENT RATES

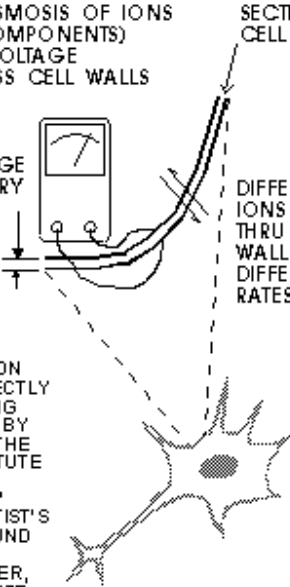

NERVE CELL

RADIO SIGNALS VS. NERVE CELLS

<http://www.raven1.net/v2skull.gif> ...ot... <http://www.bestnet.org/~raven1/v2skull.gif>

Jan 19/00

Illustration showing the principle behind pulsed microwave voice-to-skull

Appended articles:

[PM1 http://www.raven1.net/lida.htm](http://www.raven1.net/lida.htm), photo and description of the Korean War LIDA machine, a radio frequency BRAIN ENTRAINMENT device developed by Soviet Russia and used in the Korean War on allied prisoners of war. BRAIN ENTRAINMENT IS INCLUDED IN THE RADIO FREQUENCY SECTION BECAUSE THE MOST INSIDIOUS METHOD OF BRAIN ENTRAINMENT IS SILENTLY, USING RADIO SIGNALS.

[PM2 http://www.raven1.net/frev.htm](http://www.raven1.net/frev.htm), Human Auditory System Response

[PM3](http://www.raven1.net/v2s-nasa.htm) <http://www.raven1.net/v2s-nasa.htm>, NASA technical report

abstract stating that speech-to-skull is feasible

[PM4](http://www.raven1.net/v2s-kohn.htm) <http://www.raven1.net/v2s-kohn.htm>, DOD/EPA small business

initiative (SBIR) project to study the UNclassified use of voice-to-skull technology for military uses. (The recipient, Science and Engineering Associates, Albuquerque NM, would not provide me details on the telephone)

[PM5](http://www.raven1.net/bioamp.htm) <http://www.raven1.net/bioamp.htm>, Excerpts, Proceedings of

Joint Symposium on Interactions of Electromagnetic Waves with Biological Systems, 22nd General Assembly of the International Union of Radio Science, Aug 25 - Sep 2, 1987, Tel Aviv, Israel
SHOWS BIOLOGICAL AMPLIFICATION OF EM SIGNALS, pointing to relative ease with which neuro-electromagnetic signals can trigger effects

[PM6](http://www.raven1.net/v2succes.htm) <http://www.raven1.net/v2succes.htm>, Excerpt, Dr. Don R.

Justesen, neuropsychological researcher, describes Dr. Joseph C. Sharp's successful transmission of WORDS via a pulse-rate-modulated microwave transmitter of the Frey type.

[PM7](http://www.raven1.net/russ.htm) <http://www.raven1.net/russ.htm>, FOIA article circulated among

U.S. agencies describing the Russian TV program "Man and Law", which gives a glimpse into the Russian mind control efforts.
(Dr. Igor Smirnov, a major player, was used as a consultant to the FBI at the Waco Branch Davidian standoff.)

[Up to Contents](#)

=====

upper limit of human hearing which is roughly 15,000 Hz in adults.

Voice-FM uses a tone at or near that upper limit, and the speaker's voice VARIES the frequency slightly. Either a "tinnitus-like sound" or nothing is heard by the target.

Ultrasound/voice-FM can be transmitted in these ways:

- directly through the air using "air type transducers"
- directly to the brain using a modulated microwave pulse train
- through the air by piggybacking an ultrasound message on top of commercial radio or television

The use of commercial radio or television requires that the input signal at the transmitter be relatively powerful, since radio and TV receivers are not designed to pass on ultrasound messages. However, the average radio and TV receiver does not simply stop ultrasound, rather, the ability to pass ultrasound messages "rolls off", i.e. degrades, as the frequency is increased.

Today's radios and TVs can carry enough ultrasound messaging to be "heard" by the human brain (though not the ear) to be effective in conveying hypnosis. This was proven by the U.S. military forces in the Gulf War.

Ultrasound's (and voice-FM's) main advantage in mind control work is that it can carry VERBAL hypnosis, more potent than simple biorhythm entrainment.

The brain CAN "hear" and understand this "inaudible voice", while the ear cannot. Once you can convey hypnotic suggestion which cannot be

In previous decades, "subliminal advertising" using voice and images at normal frequencies were "time sliced" into an apparently normal radio or TV broadcast. This apparently did not work well, and now voice-FM "subliminal learning tapes" commercially available have superseded the time slice method.

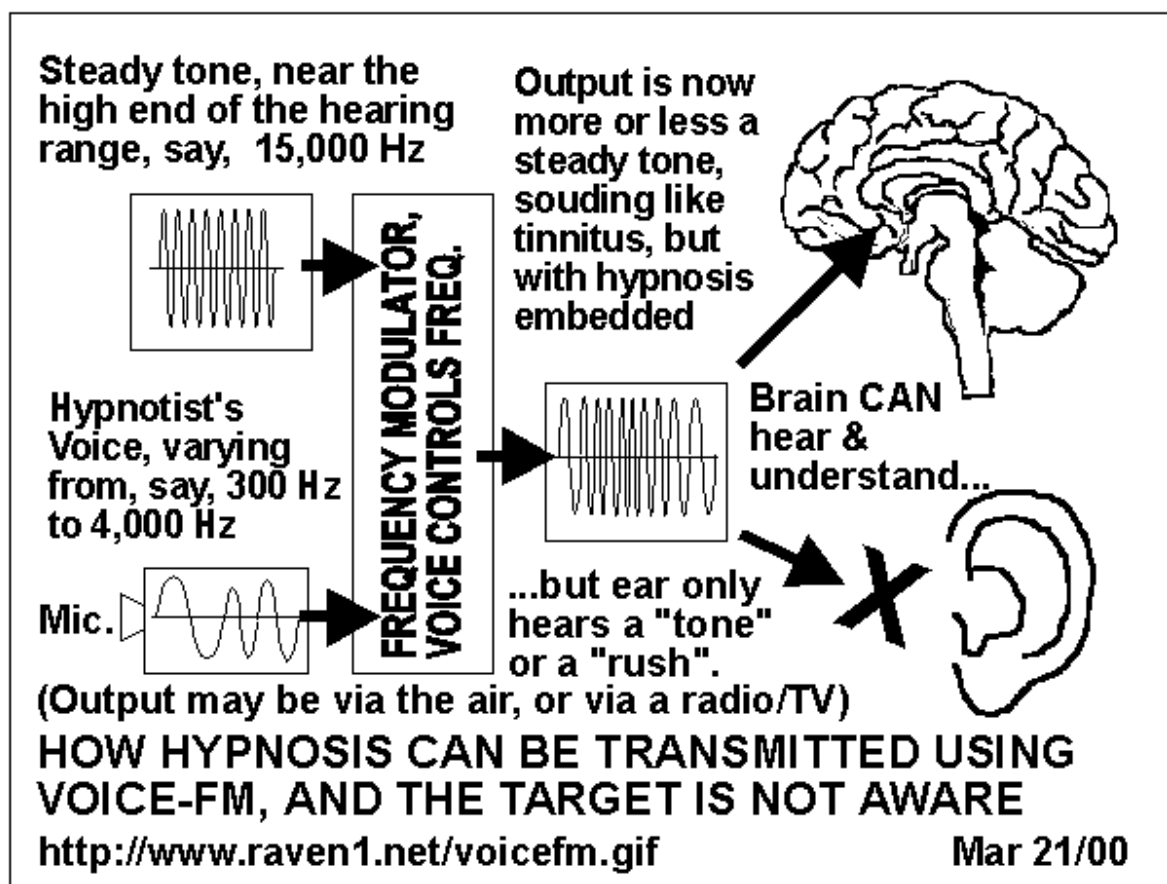

Illustration showing the operation of "silent sound" with the human hearing system, using near-ultrasound, FREQUENCY MODULATED voice

Corporation, San Diego CA, <http://www.atcsd.com>

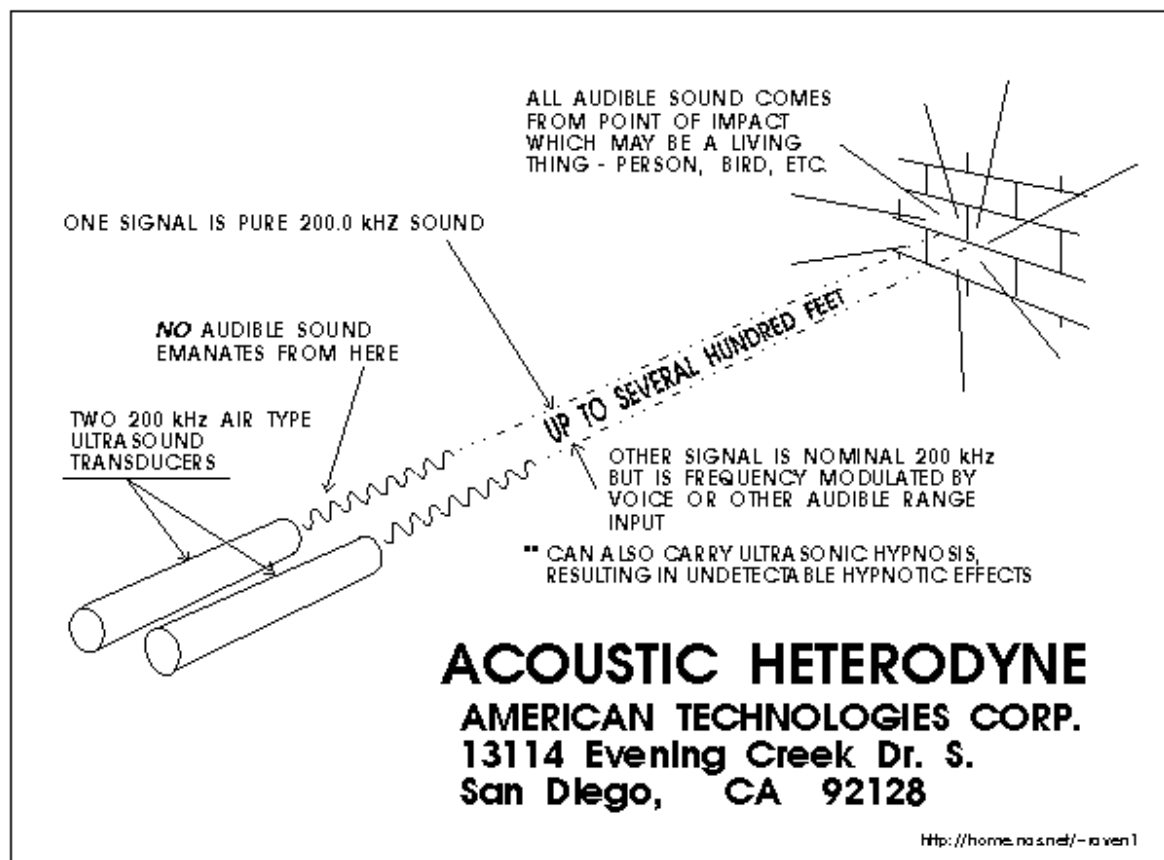

Illustration showing the principle of an ultrasound projection system capable of true ventriloquism at a distance, by American Technologies Corporation (licensor), Akai Japan (licensee)

Appended articles:

[US1 http://www.raven1.net/silsoun2.htm](http://www.raven1.net/silsoun2.htm), ITV Silent Sound report

with comments by Judy Wall, Editor, Resonance, newsletter of MENSA's

outlining instances of UNclassified, openly-admitted-to, electronic mind control operations by government agencies.

[US3](http://www.raven1.net/armyparw.htm) <http://www.raven1.net/armyparw.htm>, an SBIR (small business initiative contract) which clearly shows intent to use ultrasound as an anti-personnel weapon, including one-man portability and with power to kill

[US4](http://www.raven1.net/ssnz.htm) <http://www.raven1.net/ssnz.htm>, a commercial New Zealand company, Altered States Ltd., sells tapes which perform "suggestions" (i.e. hypnosis but not called such) using the Lowery patent voice-FM method, to hypnotize without the subject being aware. This is a key feature of neuro-electromagnetic involuntary experiments.

[US5](http://www.raven1.net/acouspot.htm) <http://www.raven1.net/acouspot.htm>, a page originally from the MIT Media Lab's acoustic engineer, Joseph Pompeii. Describes a similar technique under commercial and military development (American Technologies Corp., San Diego) under the trade name "Hypersonic Sound". Shows that sound can be focussed to the extent of targetting just one person in a crowd, acoustically, using ultrasound.

[Up to Contents](#)

=====

VII. THROUGH-WALL RADAR

When "millimeter wave" microwave signals are received, the waves are so small that they can display a two-dimensional outline of an object. Lower frequency radar can only show a "blip" which indicates an object's presence

wave signals on to a plate with a two-dimensional array of elements sensitive to millimeter wave frequencies, in exactly the same way a camera focusses light on to a piece of film. Each of the sensitive elements is scanned in a definite order, just as with a TV camera and screen, and a picture showing the outline of an object is formed.

If no signal is sent out by the scanner, it is called "passive" millimeter wave radar. If the subject is illuminated by a separate source of millimeter wave signals, it is an "active" scanner. Since passive systems can penetrate clothing and non-conductive walls UNDETECTABLY, it is obvious that with just a small millimeter wave "flashlight", non-conductive walls can be scanned through and still very little detectable signal is present.

Millimeter wave through-clothing, through-luggage is currently in use at airports.

In addition to mind control experimental observation, millimeter wave scanners are ideal for stalkers and voyeurs, since the subject is portrayed in the nude.

Millimeter wave scanners can be purchased from Millivision Corp., Northampton MA, info at <http://www.millivision.com>

Appended articles:

[TWR1](http://www.raven1.net/lads.htm) <http://www.raven1.net/lads.htm>, LADS, Life Assessment Detector

System, a product of VSE Corporation, can scan through more than a hundred feet of non-conductive or poorly-conductive material to detect a beating human heart

system above. Can also be used to illuminate a subject for use with a Millivision thru-clothing/thru-nonconductive wall scanner

[TWR3](http://www.raven1.net/millitec.htm) <http://www.raven1.net/millitec.htm>, October 1995 blurb from Popular Mechanics, with photos showing hidden guns used for demo purposes (Millitech sold the rights to Millivision)

[TWR4](http://www.raven1.net/ptscradr.htm) <http://www.raven1.net/ptscradr.htm>, March 22 text taken from Patriot Scientific Corporation's web site, their ground-penetrating radar section. Patriot's GPR overcomes the limitation of the Millivision passive radar, i.e. inability to penetrate partially conductive walls.

[Up to Contents](#)

=====

VIII. THOUGHT READING

"Thought reading" appears to be one of the EASIER components of electronic mind control, given that commercial and unclassified thought reading devices are available and being actively developed. Thought reading is an enhanced version of computer speech recognition, with EEG waves being substituted for sound waves.

The easiest "thought" reading is actually remote picking up of the electromagnetic activity of the speech-control muscles.

When we "say words to ourselves, silently", or, read a book, we can actually FEEL the slight sensations of those words in our vocal muscles - all that is absent is the passage of air. Coordinated speech signals are relatively

information from a distance is SPECULATIVE. We targetted individuals have no way to verify that is happening, however, we do know that we are "fed" hypnotic signals to force consistent "neutral" content (but of different character than prior to becoming test subjects,) DREAMS.

These forced, neutral content ("bland" content) dreams occur every single night and may represent the experimenters' efforts to have our experiences portray themselves in such dreams, in effect, MINING our experiences. Again, this is SPECULATION, but it seems very logical.

Appendix TR4, referenced below, confirms the ability of current unclassified technology to actually see what a living animal sees, electronically. It is therefore extremely likely that these forced dreams can be displayed on the experimenters' screens in an adjacent apartment or adjacent house, (which are made obvious to the involuntary experimentee.)

Finally, among the 300 known neuro-electromagnetic experimentees, we often have strangers either tell us what we are thinking, say they can pick up our broadcast thoughts, or tell us about events inside our homes at times when they could not have seen from the outside. BUGS are not used, and they have been searched for.

Appended articles:

[TR1](http://www.raven1.net/thotuncl.htm) <http://www.raven1.net/thotuncl.htm>, Commercially available thought-reading devices, both implant-style and non-implant

[TR2](http://www.raven1.net/ratrobot.htm) <http://www.raven1.net/ratrobot.htm>, Implanted rats can control devices with their thoughts

thought reading is made) at a distance by passing a radio signal through the human head and analyzing the passed-through signal.

[TR4](http://www.raven1.net/elevvisn.htm) <http://www.raven1.net/elevvisn.htm>, an article describing electronically reading a cat's brain waves and constructing a real-time image on screen from the EEG traces

[TR5](http://www.raven1.net/m_switch.htm) http://www.raven1.net/m_switch.htm, the text from a site describing a mind-controlled "switch", which can not only turn appliances on or off, but also adjust controls like volume.

[Up to Contents](#)

=====

IX. IMPLANTS

Electronic implants are actually one of the older forms of electronic mind control technology. Implants can either receive instructions via radio signals, passing them to the brain, or, can be interrogated via external radio signals to read brain activity at a distance.

Many of the about 300 known involuntary neuro-electromagnetic experimentees do not have implants, but have an aggressive and thorough regimen of mind control effects anyway. IMPLANTS ARE STILL SIGNIFICANT, though, for these reasons:

1. Their use, since World War II and continuing to the present day, associated with MKULTRA atrocities, is a crystal clear indication that a MOTIVE POOL of unethical researchers has existed through the late 1970s. The same people, none jailed, are still working,
-

2. The fact that to date (autumn 1999) no victim who has had implants removed has ever been able to get custody of the removed implant shows that research programmes using implants are still quite active and obviously quite important to someone.

See <http://www.morethanconquerors.simplenet.com/MCF/>,

the Mind Control Forum for details on involuntary experimentees' implantation and removal experiences.

3. The use of implants shows that, in the field of involuntary human experimentation, not every perpetrator group has access to the most sophisticated (implant-less) technology. Since implants for beneficial purposes are actively being promoted by NIH, it is obvious they will not disappear any time soon.

Appended articles:

[IMP1](http://www.raven1.net/centneur.htm) <http://www.raven1.net/centneur.htm>, an article showing that human implantation is being done and even encouraged by the U.S. NIH (National Institutes of Health). While this public information is for the public good, it is a small step to move from publicly known and VOLUNTARY implantation to CONCEALED implantation for INVOLUNTARY and criminal purposes.

[IMP2](http://www.raven1.net/italydoc.htm) <http://www.raven1.net/italydoc.htm>, a testimonial by an Italian psychiatrist who has been assisting involuntary experimentees; this doctor began by assisting [Satanic or other] ritual abuse victims. Apparently involuntary brain implantation is alive and well in Italy,

AF, awarded to perform unclassified research and development of human implants which can read both physio- and PSYCHO- parameters.

[IMP4](http://www.raven1.net/stimocvr.htm) <http://www.raven1.net/stimocvr.htm>, an excerpt describing human implantation for purposes of two-way communication with the brain by way of implants and FM VHF radio. Blows away any doubts that human implantation has not been done, and even more, that the U.S. military are involved.

[IMP5](http://www.raven1.net/sattrack.htm) <http://www.raven1.net/sattrack.htm>, describes an unclassified human implant satellite tracking system, ostensibly for benevolent use. (No method for avoiding unethical uses is described.) Applied Digital Solutions, Inc., Palm Beach, Florida.

[Up to Contents](#)

=====

X. CONCLUSION

Conclusion? While the documentary evidence in this report does not exactly "prove" we are being targetted by intelligence/defence contractors using classified electronic weapons, it certainly eliminates the argument that such devices are impossible, don't exist, or that government has "no interest" in them, or that the "were tried years ago but didn't work".

Add in the experiences of victims of the Tuskegee untreated syphilis experiments, the feeding of radioactive food to uninformed U.S. citizens, and the atrocities perpetrated under the institutional/drug/child abuse phases of the CIA's MKULTRA programmes, and you have more than enough grounds to petition for an independent, open investigation.

Faced with all the evidence, no honest government can afford to take the risk that electronic mind control activity may be happening, controlled from their own "back rooms".

Eleanor White

If any doubts as to the importance of this issue remain, please see below what the U.S. NSA (National Security Agency) says would be the result of releasing information on electronic mind control:



NATIONAL SECURITY AGENCY
CENTRAL SECURITY SERVICE
FORT GEORGE G. MEADE, MARYLAND 20755-6000

Serial: J9728-96

19 March 1997

Ms. Cheryl Welsh
915 Zaragoza St.
Davis, CA 95616

**Obvious question:
If government-sponsored
mind control is not happening,
then why could it "reasonably
be expected to cause
exceptionally grave damage
to national security"!?**

Dear Ms. Welsh:

This responds to your Freedom of Information Act (FOIA) request dated 28 July 1995 submitted to the Defense Intelligence Agency (DIA) for records pertaining to yourself and other various topics. A copy of your request is attached for your convenience. On 21 October 1996 the DIA referred one responsive NSA-originated document relating to a Soviet mind control system to this Agency for our review and direct response to you.

The document has been reviewed by this Agency pursuant to the provisions of the FOIA and has been found to be currently and properly classified in accordance with Executive Order 12958. This document meets the criteria for classification as set forth in subparagraphs (c) and (g) of section 1.5 and remain classified TOP SECRET as provided in section 1.3 of Executive Order 12958. The information is classified because its disclosure could reasonably be expected to cause exceptionally grave damage to the national security. Because the information is currently and properly classified, it is exempt from disclosure pursuant to the first exemption of the FOIA (5 U.S.C. section 552(b)(1)).

In addition, this Agency is authorized by various statutes to protect certain information concerning its activities. We have determined that such information exists in this document. Accordingly, those portions are also exempt from disclosure pursuant to the third exemption of the FOIA which provides for the withholding of information specifically protected from disclosure by statute. The specific statutes applicable in this case are

UP TO THIS PAGE, THIS REPORT HAS BEEN A NARRATIVE
AUTHORED BY ELEANOR WHITE. THE APPENDICES ARE
A COLLECTION OF THE BEST QUALITY FACTUAL MATERIAL
FROM OFFICIAL SOURCES OUTSIDE THE INVOLUNTARY
ELECTROMAGNETIC EXPERIMENTEE GROUP. THIS MATERIAL
MAY BE INDEPENDENTLY VERIFIED FROM REFERENCES
PROVIDED.

[Up to Contents](#)

APPENDIX PM1 ... THE LIDA MACHINE

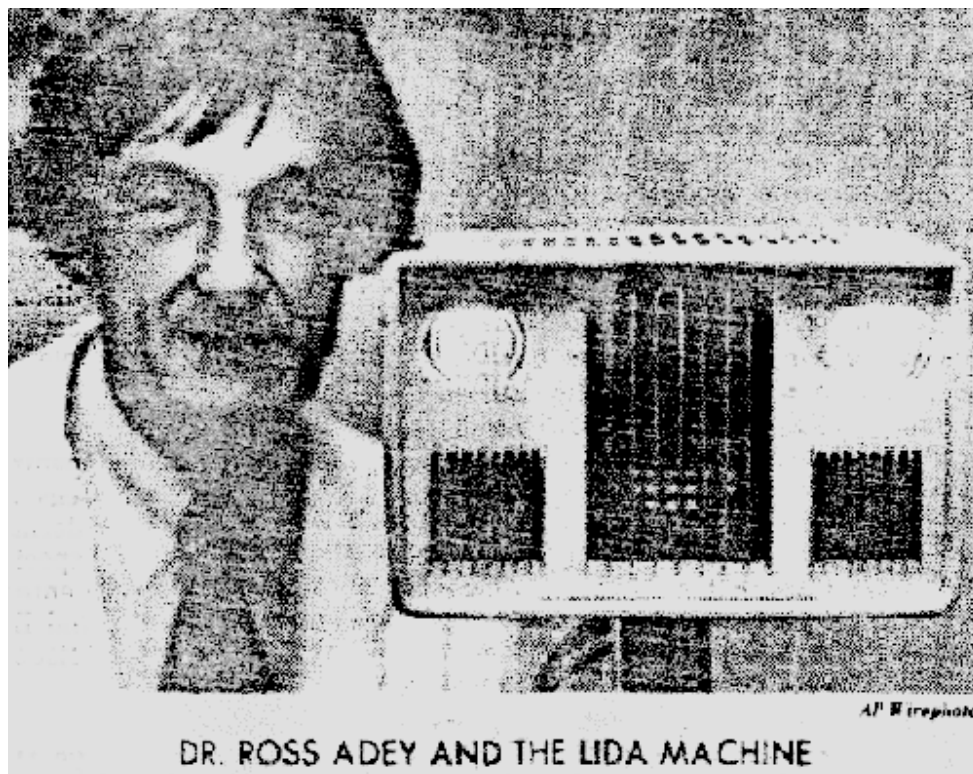

A Soviet device that bombards brains with low-frequency [Eleanor White's note: More likely radio frequency carrier which is modulated or pulsed at brain-entrainment rates] radio waves may be a replacement for tranquilizers and their unwanted side effects, says a researcher, but its use on humans poses ethical and political questions.

The machine, known as the LIDA, is on loan to the Jerry L. Pettis Memorial Veterans Hospital through a medical exchange program between the Soviet Union and the United States.

Hospital researchers have found in changes behaviour in animals.

"It looks as though instead of taking a valium when you want to relax yourself it would be possible to achieve a similar result, probably in a safer way, by the use of a radio field that will relax you" said Dr. Ross Adey, chief of research at the hospital.

[Missing one line on the photocopy] ... manual shows it being used on a human in a clinical setting, Adey said. The manual says it is a "distant pulse treating apparatus" for psychological problems, including sleeplessness, hypertension and neurotic disturbances.

The device has not been approved for use with humans in this country, although the Russians have done so since at least

current and produce a trance-like state.

Adey said he put a cat in a box and turned on the LIDA.

"Within a matter of two or three minutes it is sitting there very quietly ... it stays almost as though it were transfixed" he said.

The hospital's experiment with the machine has been underway for three months and should be completed within a year, Adey said.

Eleanor White's comments (Dr. Byrd's statement follows):

1. Heavy "fatigue attacks" are a very common experience among involuntary neuro-electromagnetic experimentees. The LIDA device could, right out of the box, be used as a fatigue attack weapon, FROM HIDING, thru non- or semi-conductive walls.

2. If the LIDA machine is tuned for tranquilizing effect, then it might also be tuned for "force awake" and other effects too. This device is a psychotronic weapon, AS IS. A TV documentary stated the Russian medical establishment considers this 1950s device obsolete. (Wonder what has taken it's place?)

Below is a statement from Dr. Eldon Byrd, U.S. psychotronic researcher who funded Dr. Adey's work with the LIDA machine:

"The LIDA machine was made in the 1950's by the Soviets. The CIA

"I provided those funds from my project in 1981, and he determined that the LIDA would put rabbits into a stupor at a distance and make cats go into REM.

"The Soviets included a picture with the device that showed an entire auditorium full of people asleep with the LIDA on the podium. The LIDA put out an electric field, a magnetic field, light, heat, and sound (of course light and heat are electromagnetic waves, but at a much higher frequency than the low frequencies of the electric and magnetic fields mentioned above).

"The purported purpose of the LIDA was for medical treatments; however, the North Koreans used it as a brain washing device during the Korean War. The big question is: what did they do with the technology? It could have been improved and/or made smaller. It is unlikely that they abandoned something that worked.

"Direct communication with Ross Adey: While he was testing the LIDA 4, an electrician was walking by and asked him where he got the "North Korean brain washing machine". Ross told him that it was a Russian medical device.

"The guy said he had been brain-washed by a device like that when he was in a POW camp. They placed the vertical plates alongside his head and read questions and answers to him. He said he felt like he was in a dream. Later when the Red Cross came and asked questions, he responded with what had been read to him while under the influence of the device. He said he seemed to have no control

US--the only one I know that exists is the one that was at Loma
Linda Medical Center where Adey used to work. Eldon"

.....

Involuntary neuro-experimentation activist Cheryl Welsh, Davis CA,
sent in this clipping from an article by Dr. Ross Adey but without
complete bibliographic references:

"Soviet investigators have also developed a therapeutic device
utilizing low frequency square wave modulation of a radiofrequency
field. This instrument known as the Lida was developed by L.
Rabichev and his colleagues in Soviet Armenia, and is designed for
"the treatment of neuropsychic and somatic disorders, such as
neuroses, psychoses, insomnia, hypertension, stammering, bronchia
asthma, and asthenic and reactive disturbances".

It is covered by U.S. Patent # 3,773,049. In addition to the
pulsed RF field, the device also delivers pulsed light, pulsed
sound, and pulsed heat. Each stimulus train can be independently
adjusted in intensity and frequency.

The radiofrequency field has a nominal carrier frequency of 40 MHz
and a maximum output of approximately 40 Watts. The E- field is
applied to the patient on the sides of the neck through two disc
electrodes approximately 10 cm in diameter. The electrodes are
located at a distance of 2-4 cm from the skin.

[Eleanor White's comment: The fact that Dr. Ross Adey mentioned

Optimal repetition frequencies are said to lie in the range from 40 to 80 pulses per minute. Pulse duration is typically 0.2 sec. In an 8 year trial period, the instrument was tested on 740 patients, including adults and children. Postivive therapeutic effects were claimed in more..."

[Up to Contents](#)

APPENDIX PM2 - FREY'S PAPER

Human Auditory System Response To Modulated Electromagnetic Energy

ALLAN H. FREY

General Electric Advanced Electronics Center Cornell University Ithaca, New York

TRANSCRIPTION, Courtesy of MindNet Archives, Mike Coyle
posted at <http://www.morethanconquerors.simplenet.com/MCF/>

Frey, Allan H., Human Auditory system response to modulated electromagnetic energy. J. Appl. Physiol. 17(4): 689-692. 1962.

(*) Asterisks indicate unreadable characters in the original copy.

NOTE: In 1962, frequencies were expressed as kiloCYCLES, megaCYCLES, etc., with abbreviations being kc, mc

induced in normal and deaf humans. The effect was induced several hundred feet from the antenna the instant the transmitter was turned on, and is a function of carrier frequency and modulation. Attempts were made to match the sounds induced by electromagnetic energy and acoustic energy.

The closest match occurred when the acoustic amplifier was driven by the rf transmitter's modulator. Peak power density is a critical factor and, with acoustic noise of approximately 80 db, a peak power density of approximately 275 mw / rf is needed to induce the perception at carrier frequencies 125 mc and 1,310 mc. The average power density can be at rf as low as 400 μ w/cm². The evidence for the various positive sites of the electromagnetic energy sensor are discussed and locations peripheral to the cochlea are ruled out.

Received for publication 29 September 1961.

A significant amount of research has been conducted with the effects of radio-frequency (rf) energy on organisms (electro- magnetic energy between 1 kc and ∞ Gc). Typically, this work has been concerned with determining damage resulting from body temperature increase. The average power densities used have been on the order of 0.1-t w/cm² used over many minutes to several hours.

In contrast, using average power densities measured in microwatts per square centimeter, we have found that ∞ effects which are transient, can be induced with rf energy. Further, these effects occur the instant the transmitter is turned on. With appropriate modulation, the perception of different sounds can be induced in

perception of severe buffeting of the head, without such apparent vestibular symptoms as dizziness or nausea. Changing transmitter parameters down, one can induce a "pins-and-needles" sensation.

Experimental work with these phenomena may yield information on auditory system functioning and, more generally, in the nervous system function. For example, this energy could possibly be used as a tool to explore nervous system coding, possibly using Neider and Neff's procedures (1), and for stimulating the nervous system without the damage caused by electrodes.

Since most of our data have been obtained of the "rf sound" and only the visual system has previously been shown to respond to electromagnetic energy, this paper will be concerned only with the auditory effects data. As a further restriction, only data from human subjects will be reported, since only this data can be discussed meaningfully at the present time. The long series of studies we performed to ascertain that we were dealing with a biological significant phenomena (rather than broadcasts from sources such as loose fillings in the teeth) are summarized in another paper (2), which also reports on the measuring instruments used in this work.

The intent of this paper is to bring this new phenomenon to the attention of physiologists. The data reported are intended to suggest numerous lines of experimentation and indicate necessary experimental controls.

Since we are dealing with a significant phenomenon, we decided to

necessary. Thus, the numbers given are conservative; they should not be considered precise, since the transmitters were never located in ideal laboratory environments. Within the limits of our measurements, the orientation of the subject in the rf field was of little consequence.

Most of the transmitters used to date in the experimentation have been pulse modulated with no information placed on the signal. The rf sound has been described as being a buzz, clicking, hiss, or knocking, depending on several transmitter parameters, i.e., pulse width and pulse-repetition rate (PRF). The apparent source of these sounds is localized by the subjects as being within, or immediately behind the head. The sound always seems to come from within or immediately behind the head no matter how the subjects twists or rotates in the rf field.

Our early experimentation, preformed using transmitters with very short square pulses and high pulse-repetition rates, seemed to indicate that we were dealing with harmonics of the PRF. However, our later work has indicated that this is not the case; rather, the rf sound appears to be incidental modulation envelope on each pulse, as shown in Fig 1.

Some difficulty was experienced when the subjects tried to match the rf sound to ordinary audio. They reported that it was not possible to satisfactorily match the rf sound to a sine wave or to white noise. An audio amplifier was connected to a variable bypass filter and pulsed by the transmitter pulsing mechanism. The subjects, when allowed to control the filter, reported a fairly satisfactory match.

high-frequency components. Since our tweeter has a rather good high-frequency response, it is possible that we have shown an analogue of visual phenomenon in which people see farther into the ultraviolet range when the lenses is eliminated from the eye. In other words, this may be a demonstration that the mechanical transmission system of the ossicles cannot respond to as high a frequency as the rest of the auditory system. Since the rf bypasses the ossicle system and the audio given the subject for matching does not, this may explain the dissatisfaction of our subjects in the matching.

FIG. 1. Oscilloscope representation of transmitter output over time (pulse-modulated).

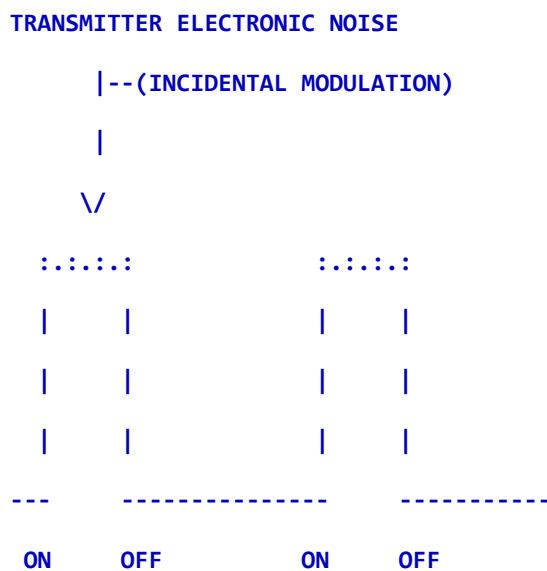

FIG. 2. Audiogram of deaf subject (otosclerosis) who had a "normal" rf sound threshold.

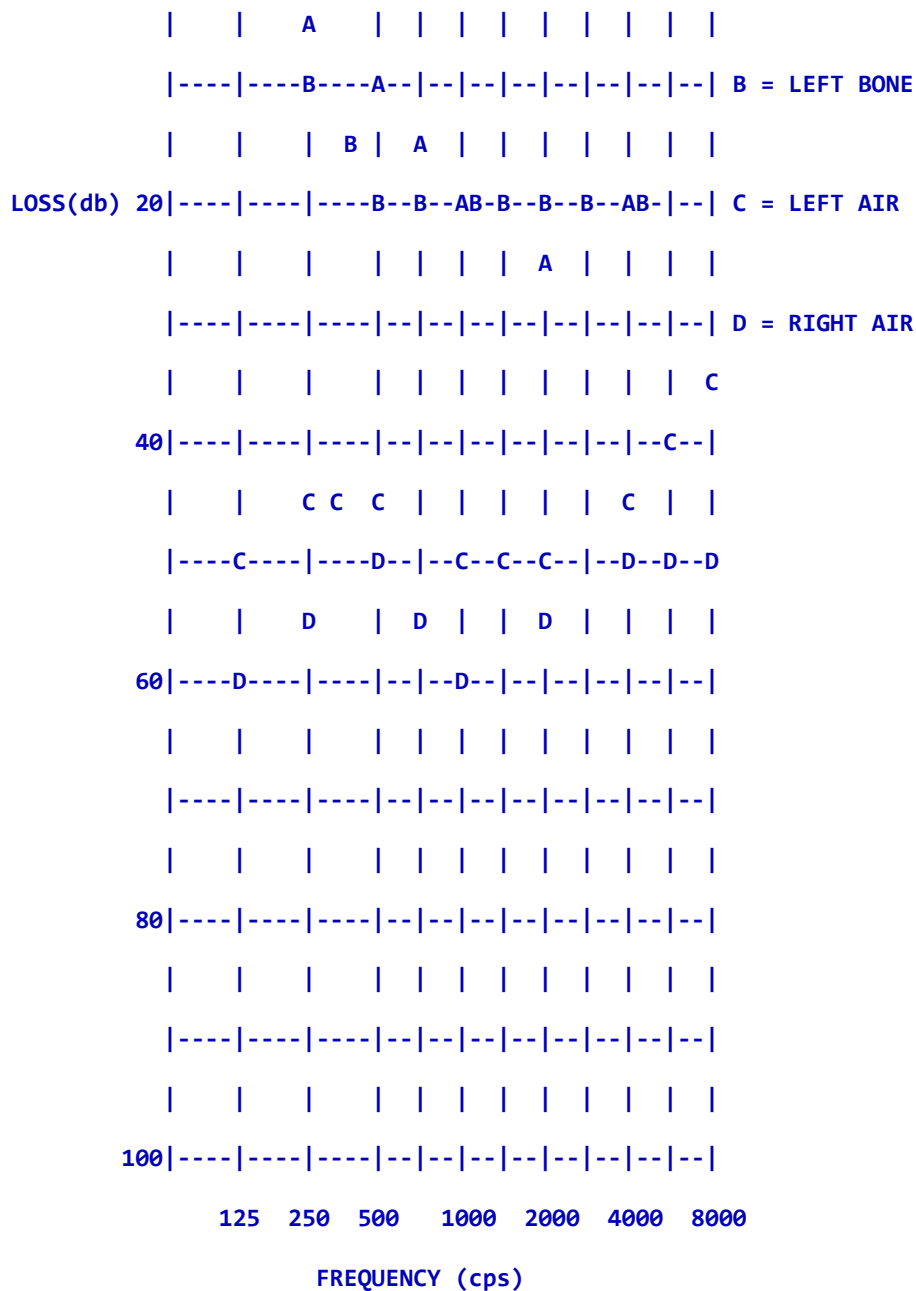
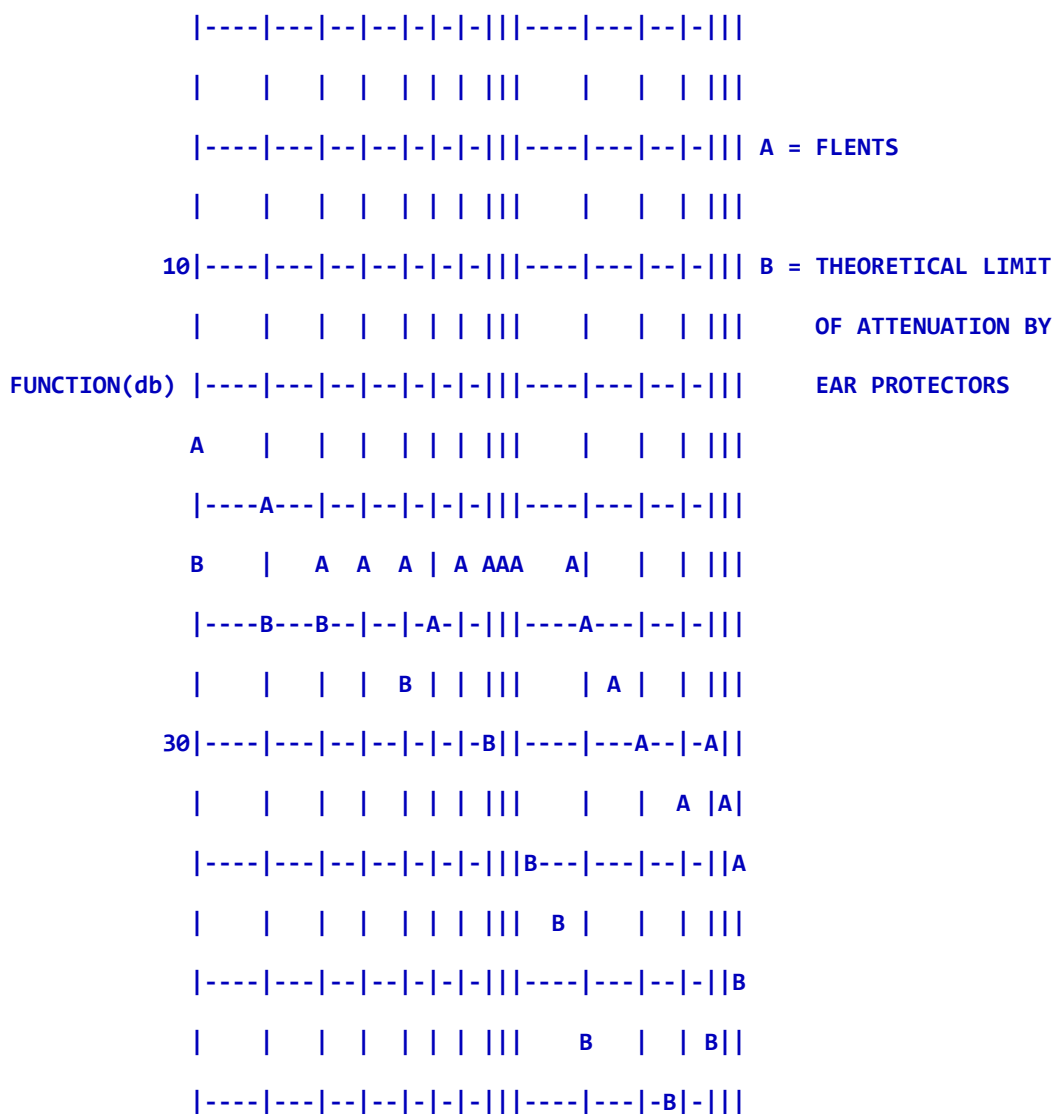

TABLE 1. Transmitter parameters

Transmitter	Frequency, mc	Wave-length, cm	Pulse Width, <u>u</u> _sec	Pulses Sec.	Duty Cy.
-------------	---------------	-----------------	----------------------------	-------------	----------

D	425	70.6	250	27	.007
E	425	70.6	500	27	.014
F	425	70.6	1000	27	.028
G	425	70.6	2000	27	.056
H	8,900	3.4	2.5	400	.001

FIG. 3. Attenuation of ambient sound with Flent antinoise stopples
(collated from Zwislocki (3) and Von Gierke (4)).



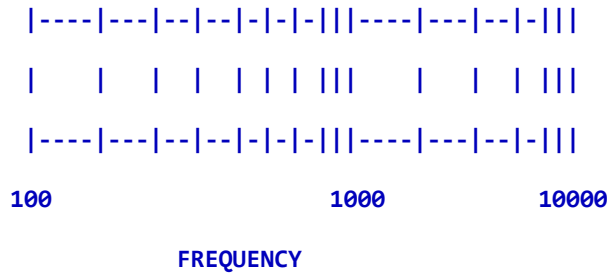

TABLE 2. Theshold for perception of rf sound (ambient noise level 70-90 db).

Transmitter	Frequency, mc	Duty Cy.	Avg Power Density, mw, cm2	Peak Power Density, mw, cm2	Peak	
					Peak Electric Field, v cm	Peak Magnetic Field, amp. turns, m
A	1,310	.0015	0.4	267	14	4
B	2,982	.0004	2.1	5,250	63	17
C	425	.0038	1.0	263	15	4
D	425	.007	1.9	271	14	4
E	425	.014	3.2	229	13	3
F	425	.028	7.1	254	14	4

FIG. 4. Threshold energy as a function of frequency of electromagnetic energy (ambient noise level 70-90 db).



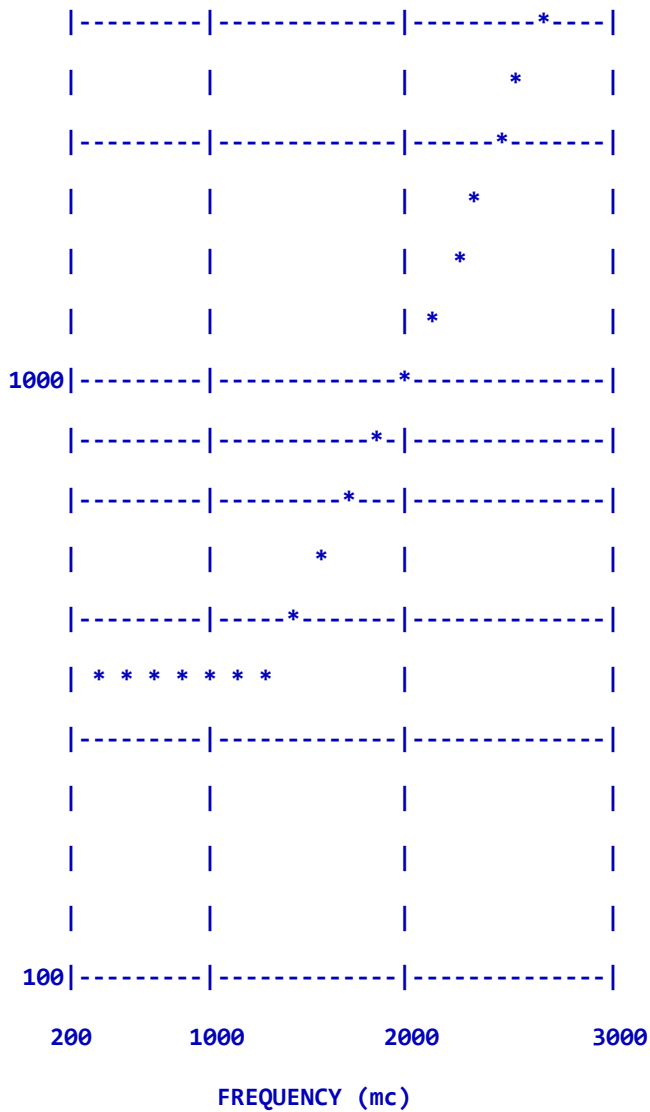

FIG. 5. Microwave power distribution in a forehead model neglecting resonance effects and considering only first reflections (from Nieset et al. (5), modified).



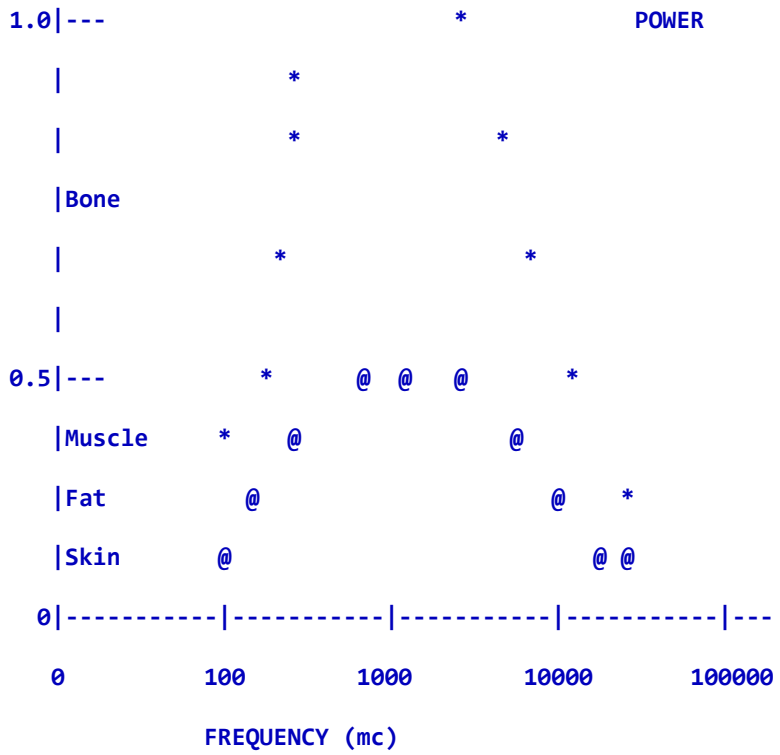
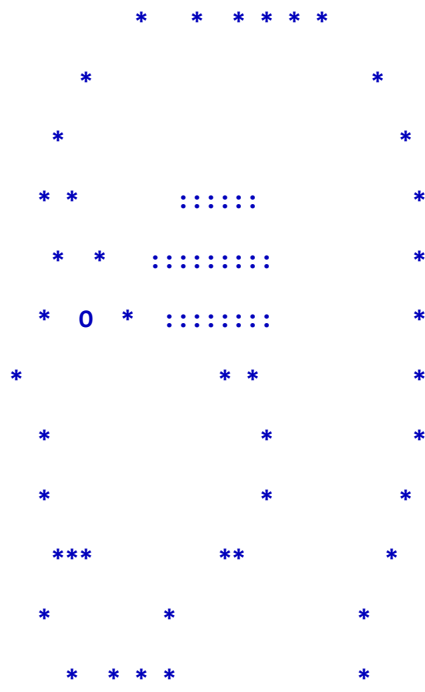

FIG. 6. Area most sensitive to electromagnetic energy (shaded portion).



At one time in our experimentation with deaf subjects there seemed to be a clear relationship between the ability to hear audio above 5 kc and the ability to hear rf sounds. If a subject could hear above 5 kc, either by bone or air conduction, then he could hear the rf sounds. For example, the threshold of the subject whose audio gram appears in Fig. 2 was the same average power density as our normal subjects. Recently, however, we have found people with a notch around 5 kc who do not perceive the rf sounds generated by at least one of our transmitters.

THRESHOLDS

As shown in Table 1, we have used a fairly wide range of transmitter parameters. We are currently experimenting with transmitters that radiate energy at frequencies below 425 mc, and are using different types of modulation, e.g., pulse-repetition rates as low as 3 and 4/sec.

In the experimentation reported in this section, the ordinary noise level was 70-90 db (measured with a General Radio Co. model 1551-B sound level meter.) In order to minimize the rf energy used in the experimentation, subjects wore Flent antinoise ear stoppers whenever measurements were made. The ordinary noise attenuation of the Flents is indicated in Fig. 3. Although the rf sounds can be heard without the use of Flents, eventhough they have an ambient noise evel of 90 db, it appears that the ambient noise to some extent "masked" the rf sound.

the rf sound is the peak power density, rather than the average power density. The relatively high value for transmitter B was expected and will be discussed below. Transmitter G has been omitted from the table since the 20-mw/cm² reading for it can be considered only approximate. The field-strength-measuring instruments used in that experiment did not read high enough to give an accurate reading. The energy from transmitter H was not perceived, even when the peak power density was as high as 25 w/cm².

When the threshold energy is plotted as a function of the rf energy (Fig. 4), a curve is obtained which is suggestive of the curve of penetration of rf energy into the head. Figure 5 shows the calculated penetration, by frequency of rf energy, into the head. Our data indicate that the calculated penetration curve may well be accurate at the higher frequencies but the penetration at the lower frequencies may be greater than that calculated on this model.

As previously noted, the thresholds were obtained in a high ambient noise environment. This is an unusual situation as compared to obtaining thresholds of regular audio sound. One recent experimentation leads us to believe that, if the ambient noise level were not so high, these threshold fields strengths would be much lower. Since one purpose of this paper is to suggest experiments, it might be appropriate to theories as to what the rf sound threshold might be if we assumed that the subject is in an anechoic chamber. It is also assumed that there is no transducer noise.

Given: As a threshold for the rf sound, a peak power density of 275 mw/cm² determined in an ambient noise environment of 80 db. Earplugs

Then: We can reduce the rf energy 50 db to -26 db as we reduce the noise level energy from 50 db to 0 db. We found that -26 db rf energy is approximately $3 \text{ } \mu\text{w}/\text{cm}^2$.

Thus: If an anechoic room, rf sound could theoretically be induced by a peak power density of $3 \text{ } \mu\text{w}/\text{cm}^2$ measured in free space. Since only 10% of this energy is likely to penetrate the skull, the human auditory system and a table radio may be one order of magnitude apart in sensitivity to rf energy.

[Up to Contents](#)

RF DETECTOR IN AUDITORY SYSTEM

One possibility that seems to have been ruled out in our experimentation is that of a capacitor-type effect with the tympanic membrane and oval window acting as plates of a capacitor. It would seem possible that these membranes, acting as plates of a capacitor, could be set in motion by rf energy. There are, however, three points of evidence against this possibility. First, when one rotates a capacitor in an rf field, a rather marked change occurs in the capacitor as a function of its orientation in the field. When our subjects rotate or change the positions of their heads in the field, the loudness of the rf sound does not change appreciably. Second, the distance between these membranes is rather small, compared with the wavelengths used. As a third point, we found that one of our subjects who has otosclerosis heard the rf sound.

are currently exploring this possibility with animal preparations.

The third likely place for the detection mechanism is the brain. Burr and Mauro (6) presented evidence that indicates that there is an electrostatic field about neurons. Morrow and Sepiel (7) presented evidence that indicates the existence of a magnetic field about neurons. Becker (personal communication) has done some work indicating that there is longitudinal flow of charged carriers in neurons. Thus, it is reasonable to suspect that possibly the electromagnetic field could interact with neuron fields. As yet, evidence of this possibility is inconclusive. The strongest point against it is that we have not found visual effects although we have searched for them. On the other hand, we have obtained other nonauditory effects and have found that the sensitive area for detecting rf sounds is a region over the temporal lobe of the brain. One can shield, with a 2-in.2 piece of fly screen, a portion of the stippled area shown in Fig. 6 and completely cut off the rf sound.

Another possibility should also be considered. There is no good reason to assume that there is only one detector site. On the contrary, the work of Jones et al. (8), in which they placed electrodes in the ear and electrically stimulated the subject, is sufficiently relevant to suggest the possibility of more than one detector site. Also, several sensations have been elicited with properly modulated electromagnetic energy. It is doubtful that all of these can be attributed to one detector.

As mentioned earlier, the purpose of this paper is to focus the attention of physiologists on an unusual area and stimulate

hoped that the additional exploration will also result in an increase in our knowledge of nervous system functions.

REFERENCES:

Neider, P.C. and W.D. Neff. Science 133: 1010, 1961.

Frey, A.H. Aero Space Med. 32: 1140, 1961.

Zwislocki, J. Noise Control 4:42, 1958.

Von Gierke, H. Noise Control 2:37, 1956.

Nifset, R., Pinneo R. Baus J. Fleming, & R. McAfee. Ann. Rept. USAF Rome Air Development Command, TR-61-65, 1961.

Burr, H., & J. Seipel, J. Wash Acad. Sci. 21: 455, 1949.

Morrow, R., & J. Seipel. J. Wash. Acad. Sci. 30: 1, 1969.

Jones, R.C., S.S. Stevens, & M.H. Laurie. J. Acoust. Sci. Am. 12: 281, 1940.

[Up to Contents](#)

APPENDIX PM3 - NASA ARTICLE

TITLE: Effects of low power microwaves on the local cerebral blood flow of conscious rats

star/80%2517043725%202044%20N19810004209recon1

.....

Eleanor White's inserted note:

See the *ITALIC* text below. This abstract has implications FAR beyond "rats"

.....

Document ID: 19810004209 N (81N12720) File Series: NASA Technical Reports

Report Number: AD-A090426

Sales Agency & Price: CASI Hardcopy or Microfiche

Authors:

Oscar, K. J. (Army Mobility Equipment Command)

Published: Jun 01, 1980

Corporate Source:

Army Mobility Equipment Command (Fort Belvoir, VA, United States)

Pages: 10

Contract Number: None

NASA Subject Category: LIFE SCIENCES (GENERAL)

Abstract:

A decoy and deception concept presently being considered is to remotely create the perception of noise in the heads of personnel by

to originate (regardless of the person's position in the field) within or just behind the head. The phenomena occurs at average power densities as low as microwatts per square centimeter with carrier frequencies from 0.4 to 3.0 GHz. *By proper choice of pulse characteristics, intelligible speech may be created.* Before this technique may be extended and used for military applications, an understanding of the basic principles must be developed. Such an understanding is not only required to optimize the use of the concept for camouflage, decoy and deception operations but is required to properly assess safety factors of such microwave exposure.

Major Subject Terms:

AUDITORY PERCEPTION

BRAIN CIRCULATION

DECEPTION

MICROWAVES

PHYSIOLOGICAL EFFECTS

RADIATION EFFECTS

Minor Subject Terms:

BIOLOGICAL EFFECTS

HEMODYNAMICS

MILITARY TECHNOLOGY

RADIATION DOSAGE

SOUND LOCALIZATION

Language Note: English

E-mail: help@sti.nasa.gov

Phone: 301-621-0390

FAX: 301-621-0134

Eleanor White's comments: I have received this report in it's entirety and I find that the article itself is about the title: Cerebral blood flow in rats. We involuntary experimentees are extremely lucky that the authors mentioned the success of microwave voice to skull transmission in this official document.

Below I have extracted some of the references to the full document which appear to be more promising and specific. This sub-list is guesswork since the references omit article titles, but any articles by Frey or Justesen are potentially useful.

1. Frey, A.H., Messenger, R. and Eichert, E.,
National Technical Information Service,
Doc. No. AD747684 (1972)

 5. Justesen, D.R., IEEE Spectrum 16, 67-68 (1979)

 7. Frey, A.H., Feld, S.R., & Frey, B. Annals of
N.Y. Academy of Science, 247, 433-439 (1975)

 18. Frey, A.H., & Messenger, R., Science 181,
356-358 (1973)

 25. Frey, A.H., & Feld, S.R., Journal of Comp.
Physiology and Psychology, 89, 183-188
-

Science 172, 398-401 (1977)

[Up to Contents](#)

APPENDIX PM4 - SEA/KOHN'S PROJECTS

Communicating Via the Microwave Auditory Effect

Web address:

http://es.epa.gov/ncerqa_abstracts/sbir/other/monana/kohn.html

Awarding Agency: Department of Defense
SBIR Contract Number: F41624-95-C-9007
Title: Communicating Via the Microwave Auditory Effect
Principal Investigator: Mr. Brian Kohn

Company Name:
Science & Engineering Assoc, Inc.
6100 Uptown Blvd NE
Albuquerque, NM 87110
Telephone Number: 505-884-2300
Business Representative:
Project Period:
Project Amount: \$739,995
Research Category: Monitoring/Analytical

Description:

An innovative and revolutionary technology is described that offers a means of low-probability-of-intercept Radio frequency (RF) communications. *The feasibility of the concept has been established* using both a low intensity laboratory system and a high power RF transmitter. Numerous military applications exist in areas of search and rescue, security and special operations.

Supplemental Keywords: small business, SBIR,
See also: <http://www.seabase.com>

Last Updated: November 17, 1997

Agency: AF Field

Office: AL

TOPIC Number: AF93-026

Control Number: 93AL -185

Contract Number: F41624-93-C-9013

Phase: 1

Awarded In: 93

Award Amount: \$37,806

Award Start Date: 17 MAY 93

Award Completion Date: 17 DEC 93

Proposal Title: Communicating Via the Microwave Auditory Effect

Principal Investigator Name: Brian Kohn

Principal Investigator Phone: 505-884-2300

Firm SCIENCE & ENGINEERING ASSOC., INC.

SEA Plaza

6100 Uptown Blvd NE

SUITE 700

Albuquerque, NM 87110

Woman Owned: N

Minority Owned: N

Number of Employees: 95

Keywords:

MICROWAVE HEARING RF HEARING

BONE CONDUCTION THERMOELASTIC

COCHLEAR MICROPHONICS

Abstract:

innovative, natural interface requiring no learning or training for efficient operation and effective communications. The purpose of the program proposed here is to extend the results of a recent feasibility study, performed for the Armstrong Laboratory/OEDR. *The study found that voice communications, via the microwave auditory effect, are highly feasible.* In Phase I of this SBIR, we propose to investigate the range of potential applications for this radically different form of voice communication and recommend hardware and systems concepts suitable for laboratory and brassboard demonstrations to be built under Phase II.

[Up to Contents](#)

APPENDIX PM5 - BIOLOGICAL AMPLIFICATION

Electromagnetic Interaction With Biological Systems

edited by Dr. James C. Lin, University of Illinois

1989 Plenum Press, New York

Proceedings of the Joint Symposium on Interactions of Electromagnetic Waves with Biological Systems, held as part of the Twenty-Second General Assembly of the International Union of Radio Science, Aug 25 - Sept 2, 1987, in Tel Aviv, Israel.

ISBN 0-306-43109-2

QP82.2.N64E44 1989

612.01448-dc19 88-38957

CIP

This book focusses on NON-ionizing radiation, and contains detailed texts about NON-THERMAL effects. In other words, "right up our alley".

The main use of this book is to show that it is easy for electromagnetic signals to cause radio frequency hearing and other effects at LOW power levels. This in turn can be used to explain why DETECTION is so very difficult.

I don't understand the biological jargon, however, a few of the more plain-language paragraphs STUNNINGLY verify that with careful choice of signal frequency and modulation, not only can the body's cells detect the modulation envelope of an incoming radio signal (i.e. function as a "cellular crystal set") but even AMPLIFY these carefully formed signals. (Amplification of other effects, such as proneness to disease, is also covered in the book.)

"Detection", in terms of radio signal reception, means that some portion of the reciever "rectifies", that is, turns the AC of the incoming signal into varying DC. If this conversion is not done, voice to skull wouldn't work.

The book touches also on ways in which cells communicate, and shows that electromagnetic fields of relatively weak power levels can affect intercellular communication, which is, as I understand the subject, what the brain is "all about".

Bio-amplification is apparently why radio signals of very low average power ("MICROWatts" per NASA) can still produce audio effects,

1. The carrier signal can be "hopped" continuously within the bioeffective bandwidth, known as "spread spectrum" transmission, and,
2. The voice modulation most effective for undetectable hypnosis is evidently a voice shifted just above normal hearing, but still audible to the brain,

...you have a recipe for incredibly difficult signals to detect.

This book is a mainstream publication, very well suited to use in our publicity and persuasion campaigns, and our dealings with authorities who claim radio signals don't affect living tissue except to heat it.

Finally, many thanks to Blanche Chavoustie for providing me photocopies of this book - a saintly work!

.....

Page 110:

...

At that time [1953] excitatory mechanisms in nerver fibers and nerve cells were grouped under a common rubric of ionic equilibrium mechanisms. There was little interest in the possibility that functional organization of mebranes of cell bodies might involve threshhold sensitivities to both oscillating EM fields and to molecular stimuli *at energy levels substantially lower* than predicted by Hodgkin-Huxley models, and *substantially below typical threshholds*

low frequency fields (and radiofrequency fields amplitude-modulated at ELF frequencies) that are many orders of magnitude weaker in the pericellular fluid [fluid between adjacent cells] than the membrane potential gradient [voltage across the membrane] can modulate actions of hormone, antibody neurotransmitter and cancer-promoter molecules at their cell surface receptor sites.

From their electrical characteristics, these sensitivities appear to involve nonequilibrium and highly cooperative processes that mediate a major amplification of initial weak triggers associated with binding of these molecules at their specific cell surface receptor sites.

(Adey, 1983, 1986, 1987; Adey and Lawrence, 1984; Lawrence and Adey, 1982).

Page 122:

Cooperative Modification of Calcium Binding by RF Fields at Cell Surfaces with Amplification of Initial Signals

Initial stimuli associated with weak perpendicular EM fields and with binding of stimulating molecules at their membrane receptor sites elicit a HIGHLY COOPERATIVE modification of Ca⁺⁺ binding to glycoproteins along the membrane surface.

As noted above, a longitudinal spread is consistent with the direction of extracellular current flow associated with

binding events by imposed RF fields that there is a far greater increase in Ca++ efflux than is accounted for in the events of receptor-ligand binding (Bawin and Adey, 1976; Bawin et al, 1975; Liu-Liu and Adey, 1982).

Page 124:

...

Enzymes are protein molecules that function as catalysts, initiating and enhancing chemical reactions that would not otherwise occur at tissue temperatures. This ability resides in the pattern of electrical charges on the molecular surface. In the fashion of more familiar chemical catalysts, such as the hydrocarbon oxidation systems which function only at very high temperatures in automotive exhaust systems, a catalyst emerges unchanged from these reactions and is thus able to participate indefinitely in a specific reaction.

Activation of these enzymes and the reactions in which they participate involve energies millions of times greater than in the cell surface cell surface triggering events initiated by the EM fields, emphasizing the MEMBRANE AMPLIFICATION inherent in this trans-membrane signaling sequence.

Page 131:

...

Stimulus Amplification in Cooperative Systems

...

It is therefore clear that OBSERVED EM field interactions with cells and tissues based on oscillating ELF tissue gradients

In part this discrepancy appears to relate to far greater sensitivities to low-frequency EM fields [EW: ELF, that is, the "entrainment" frequencies] and to RF fields with low-frequency amplitude-modulation [EW: this includes radar hearing signals] than to imposed step functions or DC gradients [EW: common with contact electrodes, not of interest in mind control at a distance] used in many electrochemical experiments and models to test levels of cooperativity in biological systems.

(Blank, 1972)

[EW: In plain language, both entrainment (ELF) fields and pulsating radar-like (RF) fields are a hell of a lot more influential on cells than some experimental work using DC and electrode methods.]

Page 95:

[EW: This section is not part of the demonstration that EM signals can be biologically amplified, as above. It's main interest is that a magnetophosphene "gun" was under consideration by the U.S. National Institute of Justice in 1993, along with a "fever" gun and a "convulsion" gun, both using microwave technology. As of 1999, nothing has been heard from NIJ on this development, however, page 95 here suggests that such a microwave weapon is feasible.]

Magnetophosphenes

ing illumination within the visual field field known as magnetophosphenes. This phenomenon occurs as an immediate response to stimulation by either pulsed or sinusoidal magnetic fields with frequencies less than 100 Hz, and the effect is completely reversible with no apparent influence on visual acuity. The maximum visual sensitivity to sinusoidal magnetic fields has been found at a frequency of 20 Hz in human subjects with normal vision.

[EW: Radio signals are a combination of electric and magnetic fields. To radiate a 20 Hz signal would require such huge antennas that it is impractical to do so. I'd recommend that if someone has the facilities and skills, I'd try some VHF (or microwave) pulsing at 20 Hz on an RF carrier at, say, the 2-meter (144-148 MHz) ham band with a duty cycle, say, of 20% pulse-ON time.]

[Up to Contents](#)

APPENDIX PM6 - VOICE TO SKULL, 1974 SUCCESS

Microwaves and Behavior

Dr. Don R. Justesen

Laboratories of Experimental Neuropsychology

Veterans Administration Hospital

Kansas City, Missouri

as published in

American Psychologist

Journal of the American Psychological Association

*This LAYS TO REST ANY DOUBTS THAT VOICE TO SKULL
TECHNOLOGY DOES NOT EXIST OR IS "IN THE FUTURE!"
PERIOD!*

*This article describes in precise terms how Dr. Joseph C.
Sharp and staff transmitted the WORDS for the digits 1 to 10
using a modulated version of an Allan Frey type pulsed
microwave transmitter. A detailed description of Frey
transmitters can be viewed at:*

[Appendix PM2](#)

The relevant text is below.

.....

Page 396:

...

*The demonstration of sonic transduction of microwave energy
by materials lacking in water LESSENS the likelihood that a
thermohydraulic principle is operating in human perception
of the energy. Nonetheless, some form of thermoacoustic
transduction probably underlies perception. If so, it is
clear that simple heating is NOT a sufficient basis for the
Frey effect; the requirement for pulsing of radiations
appears to implicate a thermodynamic principle.*

*Frey and Messenger (1973) and Guy, Chou, Lin, and Christen-
sen (1975) confirmed that a microwave pulse with a slow rise*

radiated radio-frequency energy, does the auditory response occur.

[Eleanor's comment: This is why we don't "hear" ordinary radio and TV signals.]

Thus the rate of change (the first derivative) of the waveform of the pulse is a CRITICAL factor in perception. Given a thermodynamic interpretation, it would follow that information can be encoded in the energy and "communicated" to the "listener".

Communication has in fact been demonstrated. A. Guy (Note 1), a skilled telegrapher, arranged for his father, a retired railroad telegrapher, to operate a key, each closure and opening of which resulted in a pulse of microwave energy. By directing the radiations at his own head, complex messages via the Continental Morse Code were readily received by Guy.

Sharp and Grove (note 2) found that appropriate modulation of microwave energy can result in "wireless" and "receiverless" communication of SPEECH. The recorded by voice on tape each of the single-syllable words for digits between 1 and 10. The electrical sine-wave analogs of each word were then processed so that each time a sine wave crossed ZERO REFERENCE IN THE NEGATIVE DIRECTION, a brief pulse of microwave energy was triggered.

By radiating themselves with these "voice modulated" microwaves, Sharp and Grove were READILY able to hear, identify, and distinguish among the 9 words. [Typo?]

The sounds heard were not unlike those emitted by persons with artificial larynxes.

Communication of more complex words and of sentences was not attempted because the averaged densities of energy required to transmit longer messages would approach the current 10 milliwatts per square centimeter limit of safe exposure.

The capability of communicating directly with a human being by "receiverless radio" has obvious potentialities both within and without the clinic. But the hotly debated and unresolved question of how much microwave radiation a human being can safely be exposed to will probably forestall applications within the near future.

...

[Up to Contents](#)

APPENDIX PM7 - U.S. GOVT DOCUMENT RE: RUSSIAN MIND CONTROL

[A Warning to the World from Russian Psychotronic Researchers](#)

Unclassified FOIA document, courtesy Cheryl Welsh, which is a bulletin circulated among U.S. government agencies reviewing an October 6, 1995

transcribed sound track, in English is posted at:

<http://www.raven1.net/russvid.htm>

Here are the images of the FOIA document:

UNCLASSIFIED

PAGE:0049

SERIAL: MS2410171895

BODY

PASS: ATTN USIS MOSCOW
COPY TO TV CENTER

COUNTRY: CIS

SUBJ: VIDEO SELECTION LIST: MOS 95-5770

REF: LD0710162495 MOSCOW RUSSIAN PUBLIC TELEVISION RUSSIAN
061610--SCIENTISTS DISCUSS MIND CONTROL TECHNOLOGY

SOURCE: MOSCOW RUSSIAN PUBLIC TELEVISION FIRST CHANNEL NETWORK IN
RUSSIAN 1610 GMT 6 OCT 95

TEXT:

FROM THE "MAN AND LAW PROGRAM

PROGRAM INCLUDES A 5-MINUTE REPORT OVER VIDEO BY YURIY VOROBYEVSKIY ON PSYCHOTRONIC WEAPONS. REPORT OPENS WITH FOOTAGE OF BRANCH DAVIDIAN SIEGE AND THE CLAIM THAT FBI HAS USED A PSYCHOTRONIC DEVICE DEVELOPED BY MOSCOW SCIENTIST IGOR SMIRNOV. VIDEO INCLUDES FOOTAGE OF SMIRNOV'S LABORATORY, INTERVIEW WITH SMIRNOV ON POSSIBLE USES OF PSYCHOTRONIC TECHNOLOGY; FOOTAGE OF SPECIAL-TROOP RECRUITS UNDER INSTRUCTION SAID TO HAVE BEEN FILMED AT AN MVD RESEARCH INSTITUTE; INTERVIEW WITH ALEKSANDR KACHUROV, MEMBER OF MOSCOW PSYCHOTRONIC INSTITUTE, WHO SAYS PSYCHOTRONIC DEVICES ARE AVAILABLE TO PEOPLE WHO ARE WILLING TO PAY FOR THEM. PROGRAM ALSO INCLUDES INTERVIEWS WITH SCIENTIST VALERIY KANYUKA AND STATE DUMA EXPERT YURIY LOPATIN CALLING FOR LEGISLATION BANNING ILLEGAL DEVELOPMENT AND SALE OF MIND-CONTROL DEVICES. (TIME INTO PROGRAM: 1622:23-1627:29; GOOD RECEPTION)

24/1833Z OCT WC 139

UNCLASSIFIED

UNCLASSIFIED

PAGE:0050

INQUIRE=DOC32D
ITEM NO=00407862

DTG 071624Z OCT 95
FROM FM FBIS LONDON UK
TO TO RUCMAAA/FBIS RESTON VA

RHHMCMY/JICPAC HONOLULU HI
RDCMACC/CDE PSYOPGF FT BRAGG NC//ASOF-POG-SB//
RUEMONT/ONI WASHINGTON DC//2140//
RUDPMAX/FAISA FT BRAGG NC
RUDPWDC/DA AMHS WASHINGTON DC
RUEALIS/STORAGE CENTER FBIS RESTON VA
RUEALGX/DEFINTAGENCY WASH DC
RUEBFGA/VOA WASHINGTON DC
RUEHC/SECSTATE WASHINGTON DC//INR/CEE//
RUETIIV/MPC FT GEO G MEADE MD
RUMTAEA/NAIC WRIGHT PATTERSON AFB OH//TAI//
CONTROLS
UNCLAS 3B/MNU/RUSS

SERIAL: LDD710162495
BODY
PASS: COPY TO TV CENTER

COUNTRY: RUSSIA
SUBJ: SCIENTISTS DISCUSS MIND CONTROL TECHNOLOGY

TEXT:

(((FBIS EDITORIAL REPORT)) MOSCOW RUSSIAN PUBLIC TELEVISION
FIRST CHANNEL NETWORK IN RUSSIAN AT 1610 GMT ON 6 OCTOBER DURING THE
"MAN AND LAW" PROGRAM CARRIES A FIVE-MINUTE FEATURE ON MIND-CONTROL
TECHNOLOGY.

ANNOUNCER YURIY VOROBYEVSKIY BEGINS BY SAYING THE FBI HAS ALREADY
USED A "PSYCHOTRONIC" DEVICE DEVELOPED BY A MOSCOW SCIENTIST, IGOR
SMIENOV. VOROBYEVSKIY THEN SHOWS VIDEO FOOTAGE FILMED AT SMIENOV'S
LABORATORY. A MAN IN A SPECIALLY FITTED HELMET WITH ELECTRIC CABLES
ATTACHED IS SITTING IN FRONT OF A SPECIAL SCREEN ON WHICH VARIOUS
ENCODED MESSAGES FLASH. VOROBYEVSKIY SAYS: "THE CODED SIGNAL IS
BEING PICKED UP THROUGH EARPHONES AS A LIGHT RUSTLE. HOWEVER, THIS
IMPERCEPTIBLE COMMAND REACHES THE BOTTOM LAYERS OF CONSCIOUSNESS.
THIS METHOD IS USED FOR TREATING NERVOUS, PSYCHIATRIC, AND OTHER
DISORDERS. BUT THE QUESTION IS: COULD THIS BE USED AS THE NOTORIOUS
PSYCHOTRONIC WEAPON?"

NEXT, VOROBYEVSKIY INTRODUCES VIDEO FOOTAGE WHICH HE SAYS WAS
FILMED THREE YEARS AGO AT A RESEARCH INSTITUTE OF THE RUSSIAN
MINISTRY OF INTERNAL AFFAIRS. IT SHOWS A CLASS OF OMON SPECIAL-
PURPOSE TROOP RECRUITS APPARENTLY IN A HYPNOTIC TRANCE LOOKING AT A
TELEVISION SCREEN. THIS SHOWS A MAN DRESSED IN BLACK WHO IS
ENCOURAGING FEELINGS OF CONFIDENCE IN HIS AUDIENCE. AN IMAGE OF A
FEMALE NUDE IS USED TO REINFORCE THE DESIRE FOR SUPERIORITY AND MALE
DOMINANCE.

UNCLASSIFIED

UNCLASSIFIED

PAGE: 0051

IGOR SMIRNOV, CAPTIONED AS MEMBER OF THE COMPUTER PSYCHOTECHNOLOGY INSTITUTE, PROPOSES THE USE OF "INDIRECT METHODS" TO FIGHT DRUG ADDICTION. HE SAYS: "THIS COULD BE DONE STRAIGHT FROM THE TELEVISION SCREEN, IN A SPECIAL PROGRAM, AT AN APPOINTED TIME OF THE WEEK. THE TIME SHOULD BE ANNOUNCED IN ADVANCE, WITH A WARNING THAT SPECIAL SUBLIMINAL COMMANDS WILL BE BROADCAST, SO THAT THOSE WHO ARE AFRAID SOMETHING COULD HAPPEN TO THEM CAN SWITCH OFF AT THAT TIME."

ANOTHER SCIENTIST, VALERIY KANYUKA, HEAD OF A PSYCHOTRONIC RESEARCH CENTER NEAR MOSCOW, DISAGREES WITH SUCH METHOD, STATING: "UNTIL ALL THE COUNTRIES OF THE WORLD AGREE ON THIS, UNTIL INTERNATIONAL LEGISLATION BANNING PSYCHO-PHYSICAL MANIPULATION OF THE HUMAN MIND AND INFLUENCE ON HUMAN BEHAVIOR HAS BEEN DEVELOPED, THERE SHOULD BE A MORATORIUM ON SUCH RESEARCH." VOROBYEVSKIY SAYS KANYUKA APPEALED WITHOUT SUCCESS TO THE FORMER RUSSIAN SUPREME SOVIET IN A LETTER MENTIONING "CLASSIFIED DECISIONS OF THE CPSU CENTRAL COMMITTEE ON THE SUBJECT OF REMOTE INFLUENCING OF THE MIND." VIDEO SHOWS KANYUKA AND A TYPED LETTER.

VOROBYEVSKIY THEN INTRODUCES ALEKSANDR KACHUROV, CAPTIONED AS MEMBER OF MOSCOW PSYCHOTRONIC INSTITUTE. KACHUROV OPENS A BRIEFCASE WITH SOME DEVICE INSIDE AND SAYS: "ANYONE WHO WANTS TO POSSESS SOMEONE'S SECRETS IS WELCOME TO ORDER A SPECIAL DEVICE FOR THEMSELVES, AS LONG AS THEY ARE PREPARED TO PAY FOR IT. ANYTHING CAN BE MADE. WHAT ABOUT THE MORAL ASPECT, PEOPLE MIGHT ASK. SOME SAY: IT IS WRONG, YOU ARE MAKING PSYCHOTRONIC WEAPONS." VOROBYEVSKIY INTERJECTS: "LET'S SAY, THE MILITARY ORDERS YOU TO DESIGN A CERTAIN TYPE OF EQUIPMENT?" KACHUROV SAYS: "YES, BUT, EXCUSE ME, THE MILITARY-INDUSTRIAL COMPLEX IS THE MOST POWERFUL INDUSTRIAL GROUP THERE IS. WHAT ARE WE TALKING ABOUT? WE ARE ALL DEVELOPING WEAPONS OF THIS KIND. ARE NUCLEAR WEAPONS ANY WORSE?"

VOROBYEVSKIY SAYS LAWS ARE BADLY NEEDED TO PROTECT THE INDIVIDUAL FROM ALL TYPES OF MIND CONTROL.

A STATE DUMA EXPERT, YURIY LOPATIN SAYS: "PSYCHOTRONIC TECHNOLOGY IS SPREADING ILLEGALLY. A LAW BANNING THE ILLEGAL DEVELOPMENT, PRODUCTION, RETAILING, AND SPREADING OF PSYCHOTRONIC DEVICES WHICH INFLUENCE THE MINDS AND BEHAVIOR OF CITIZENS IS BADLY NEEDED." HE GOES ON TO SAY: "THE USE OF THE MASS MEDIA FOR PSYCHOLOGICAL EXPERIMENTS SHOULD BE BANNED AND ALL THE STATE-ORDERED RESEARCH IN HUMAN GENETIC EXPERIMENTS SHOULD BE STRICTLY REGISTERED. THIS WAS APPROVED BY GEORGIY GEORGIYEVICH ROGOZIN, FIRST DEPUTY HEAD OF THE PRESIDENTIAL SECURITY SERVICE."

VOROBYEVSKIY QUESTIONS WHAT MIGHT HAPPEN WERE SUCH TECHNOLOGY TO FALL INTO THE HANDS OF UNSCRUPULOUS PEOPLE. HE SAYS NO ONE CAN FEEL SECURE UNTIL SPECIAL LAWS ARE PASSED.

NO FURTHER PROCESSING PLANNED. [REDACTED] 07/1631Z OCT WC 638

UNCLASSIFIED

[Up to Contents](#)

*RESEARCH INTO RADIO FREQUENCY WEAPONS. I HAVE PHONED THEM AND THE
1993 NEWS RELEASE BELOW IS GENUINE. E.W.*

.....
*Date sent: Fri, 10 May 1996 17:52:55 -0700 (PDT)
To: MindNet@c2.org
From: vericomm@c2.org
Subject: MindNet Journal - Vol. 1, No. 73*

V E R I C O M M / MindNet "Quid veritas est?"

Sender: Owner-MindNet@c2.org

*The views and opinions expressed below are not necessarily the
views and opinions of VERICOMM, MindNet, or the editors unless
otherwise noted.*

*Permission is given to reproduce and redistribute, for
non-commercial purposes only, provided this information and the
copy remain intact and unedited.*

Editor: Mike Coyle

Assistant Editor: Rick Lawler

Research: Darrell Bross

*PHYSIOLOGICAL RESPONSES APPLICABLE TO DEVELOPMENT OF
LESS-THAN-LETHAL WEAPONS*

*Physiological Responses Applicable to Development of
Less-Than-Lethal Weapons*

Sponsored by National Institute of Justice

Oak Ridge National Laboratory

Less-than-lethal weapons have a variety of applications in law enforcement, including rescuing hostages, stopping fleeing felons, and quelling prison disturbances. The National Institute of Justice is sponsoring a broad program to develop new techniques for "friendly force" as an alternative to the use of deadly force. As part of this program, Oak Ridge National Laboratory (ORNL) is examining approaches based on known physiological responses to certain types of stimuli. These "weapons" would temporarily incapacitate an individual or a group with no lasting physiological damage. These concepts are based on ORNL's experience and expertise in biological-based systems and biophysical responses, particularly in evaluating the physical responses of humans to a variety of chemical, physical and radiological agents. ORNL also has extensive experience and expertise in risk analysis and in risk assessment and modeling.

The ORNL less than-lethal weapons project sponsored by the National Institute of Justice began in September 1993. The following tasks are being performed:

** Locate and compile data from tests, accidents, medical*

mechanisms for further development for a friendly force

- * Evaluate the applicability of the proposed approaches to several realistic scenarios (such as hostage rescue or riot control).*

ORNL has already examined several possible concepts for less-than-lethal weapons based on known physiological responses to energetic stimuli, including a thermal gun, a seizure gun, and a magnetophosphene gun. A thermal gun would have the operational effect of heating the body to 105 to 107F, thereby incapacitating any threat, based on the fact that even a slight fever can affect the ability of a person to perform even simple tasks. This approach is built on four decades of research relating radio frequency exposure to body heating. A seizure gun would use electromagnetic energy to induce epileptic-like seizures in persons within the range of a particular electromagnetic field. The magnetophosphene gun is designed around a biophysical mechanism which evokes a visual response and is thought to be centered in the retina, known as magnetophosphenes. This effect is experienced when a person receives a blow to the head and sees "stars". This same effect can be produced with electromagnetic energy. While there are a number of technical challenges to be overcome in building devices of these types, less-than-lethal weapons based on physiological responses to energetic stimuli would provide a safe and effective means of dealing with a number of law enforcement situations where use of deadly force is not desirable.

Sherrow, Oak Ridge Special Projects Office (615) 576-8024

*Oak Ridge National Laboratory is a U.S. Department of Energy
Laboratory Managed by Martin Marietta Energy Systems, Inc.*

.....

MindNet Journal Archive Filename: [mn173.txt]

To receive the MindNet Journal via email:

Send message: [subscribe mindnet] to: .

To unsubscribe:

Send message: [unsubscribe mindnet] to: .

Back issues of the MindNet Journal are available at our=20

FTP Archive site:=20

[/pub/users/vericomm/mindnet/]

MindNet Journal Publication Index: [mnindex.txt]

*Submission of articles for publication within the MindNet
Journal on the subjects of mind control, directed-energy
weapons, non-lethal weapons, ritual abuse, UFO abductions,
bioelectromagnetics, hypnosis, and other related topics
will be accepted with the author's statement of permission
to publish. The editor reserves the right to accept or
reject for publication. The publisher disclaims all*

, or VERICOMM BBS 510.891.0303, or VERICOMM,
POB 32314, Oakland, CA 94604-2314 USA.

VERICOMM / MindNet and its agents disclaim any and all
responsibility or liability for any and all claims and/or
guarantees, express or implied, and delivery of products,
merchandise, and/or services offered for sale by
advertisers and/or authors within the MindNet Journal.

The MindNet mailing list is owned and maintained by Mike Coyle,
, VERICOMM / MindNet, POB 32314 Oakland, CA
94604-2314 USA.

The MindNet Journal is published by VERICOMM / MindNet in=20
cooperation with the Freedom Of Thought Foundation, POB 35072,
Tucson, AZ 85740-5072 USA.

.....

Los Angeles Herald Examiner, Section A, November 22, 1976

Mind-Altering Microwaves: Soviets Studying Invisible Ray

A newly declassified U.S. Defense Intelligence Agency report
says extensive Soviet research into microwaves might lead to
methods of causing disoriented human behavior, nerve disorders,
and even heart attacks.

...

...

Sounds and possibly even words which appear to be originating intercranially (within the head) can be induced by signal modulation at very low average power densities, the study said.

...

One physiological effect which has been demonstrated is heart seizure, the report said.

It said this has been accomplished experimentally in frogs by synchronizing the pulses of a microwave signal with the animal's heartbeat and beaming the radiation at the chest area.

.....

Microwave News, January-February 1987

ZAP!

Six hundred scientists and engineers with security clearances spend the first week of December at Kirtland Air Force Base in New Mexico examining the potential of high-power microwaves to zap enemy electronics...

... Many branches of the Department of Defense were represented, including the Air Force, the Army and the Navy, together with

high-power microwave testing facility.

In addition to these sources, susceptibility and hardening, there was one on biological effects: Dr. David Erwin and Major Robert Downs represented the Air Force and Howard Bassen and Dr. John D'Andrea described the Army and Navy programs, respectively. Dr. Frank Barnes of the University of Colorado in Boulder presented a poster paper on his and Dr. Howard Wachtel's research on the effects of pulsed microwaves.

Chuck de Caro, a former correspondent for the Cable News Network, considers the possibility that the U.S. is falling behind the U.S.S.R. in microwave weapons in "The Zap Gap", to be published in the March issue of "The Atlantic" (see also MWN November-December 1986).

.....
Microwave News, January-February 1996

RF WEAPONS - Disabling People and Electronics

The military continues to explore development of RF weapons for the conflicts of the future. For instance, the "First Directed Energy Warfare (DEW) Conference", held last year at the Mitre Corp. in McLean VA, featured Dr. David Erwin of the Armstrong Lab at Brooks AFB, San Antonio, TX, on "Directed Energy Warfare RF Effects", and D.r Jose Pina of the CIA on "Ground Combat Applications of RF". Other topics included "Personnel Vulnerability" and Directed Energy

Crows, whose members are specialists in electronic warfare. Conference participants had to have security clearances of "Secret" or higher, as has been the case at similar meetings in the past (See MWN, J-F 87 and N-D 93).

Public discussions of RF/MW weapons have focussed on disrupting technology. But a recent Article in the Airpower Journal revealed "for the first time that the military is developing high-powered microwave weapons for use against human beings", reports Peter Cassidy in the January 1996 "Progressive" (see p. 14).

RF/MW and EMF-based weapons are also being studied for civilian law enforcement. Oak Ridge National Laboratory (ORNL) in Oak Ridge TN will soon complete a literature review for the National Insitute of Justice on the feasibility of "thermal guns" which could heat the body to 105 to 107 degrees F and incapacitate the target; "seizure guns" which would use EM energy to induce epileptic-like seizures; and "magnetophosphene guns" which would cause the target to "see stars".

The institute's Ray Downs in Washington cautioned that the report may not be made public. ORNL's Dr. Clay Easterly has said that some effects not associated with heating could be useful in developing nonlethal weapons.

(See MWN, N-D 93.)

.....

They're the sexiest gadgets in this year's action movies: EMP weapons, which use electromagnetic pulses to zap electronics. They have starring roles in Goldeneye, the latest James Bond movie, as well as in Broken Arrow, Escape From LA, and Eraser. And soon they may be coming to a police car near you.

Law Enforcement News (September 30) reports that the U.S. Army and the National Institute of Justice are running a \$500,000 field test to see if EMP guns can force a car to stop by disabling its electrical systems. The plan is to use EMP to do away with high speed chases (another Hollywood staple). This is another example of the growing interest in using nonlethal weapons developed by the military.

...

[Up to Contents](#)

APPENDIX US1 - SILENT SOUND

Eleanor White's comments:

This article shows clearly the military's intent to use every possible thought-influencing technology. This technology is largely classified but there are leaks, like this article. We involuntary test subjects can tell you from first hand experience that far more invasive devices now exist.

further developed:

- *Radio frequency signals, based on the WW II phenomenon called "radar hearing"*

- *Ultrasound signals, which can be transmitted through the air or piggybacked on to radio/TV signals*

.....

NEXUS

Volume 5, Issue 6

October/November 1998

\$25/6 issues/ 1 year

1998 Nexus New Times

888-909-7474

nexus@peg.apc.org

EXCERPT: More in magazine.

Military Use of Mind Control Weapons

Judy Wall 1998

PSY-OPS WEAPONRY USED IN THE PERSIAN GULF WAR

For years, rumours have persisted that the United States Department of Defense has been engaged in research and development of ultra-sophisticated mind- altering technology. Confirmation of this

The March 23, 1991 newsbrief, "High-Tech Psychological Warfare Arrives in the Middle East", describes a US Psychological Operations (PsyOps) tactic directed against Iraqi troops in Kuwait during Operation Desert Storm. The manoeuvre consisted of a system in which subliminal mind-altering technology was carried on standard radiofrequency broadcasts. The March 26, 1991 newsbrief states that among the standard military planning groups in the centre of US war planning operations at Riyadh was "an unbelievable and highly classified PsyOps program utilising 'silent sound' techniques".

The opportunity to use this method occurred when Saddam Hussein's military command-and-control system was destroyed. The Iraqi troops were then forced to use commercial FM radio stations to carry encoded commands, which were broadcast on the 100 MHz frequency. The US PsyOps team set up its own portable FM transmitter, utilising the same frequency, in the deserted city of Al Khafji. This US transmitter overpowered the local Iraqi station. Along with patriotic and religious music, PsyOps transmitted "vague, confusing and contradictory military orders and information".

Subliminally, a much more powerful technology was at work: a sophisticated electronic system to 'speak' directly to the mind of the listener, to alter and entrain his brainwaves, to manipulate his brain's electroencephalographic (EEG) patterns and artificially implant negative emotional states-feelings of fear, anxiety, despair and hopelessness. This subliminal system doesn't just tell a person to feel an emotion, it makes them feel it; it implants that emotion in their minds.[2]

Electromagnetic Weapons Timeline in issue no. 29, reference is made to the documentary video, Waco: The Big Lie Continues, which contained video footage of three EM weapons. This segment of the film was from the British Broadcasting Corporation (BBC). I wondered if there was any significance to this.

At the library I pulled up back issues of my local newspaper for the same time-period of the Gulf War to see what the American wire services had said, if anything, about the use of this special PsyOps weapon. There was nothing said about it directly, but three news articles seemed related. In a news release from Associated Press during the same timeframe of the Gulf War truce, I read:

"The American pilot who shot down the second Iraqi warplane in 48 hours said Friday that continued Iraqi flights suggested that US warnings were not filtering down to Iraqi pilots... He said he hopes Saddam gets the message now. 'It's really too bad that these people have to die for their unwillingness to heed our warnings... What I really think is, they don't communicate down to the people,' he said. 'If they have a communications problem, I suggest they fix it.'"[3]

That may have been coincidence but two earlier news articles, dated March 1, 1991, apparently have a common origin with the ITV news bulletin. The first article[4] tells us that approximately 100 members of the US 101st Airborne Division, fluent in Arabic, talked the enemy into surrendering. These soldiers rode in the Apache helicopter gunships that were involved in the longest helicopter-borne assault in history. They told the Iraqi troops

This all sounds very unremarkable, except when you read the editor's note: "The following dispatch was subject to US military censorship." Now why would they want to censor such a mundane tactic, except out of embarrassment that the US Army fighting forces had fallen to the level of a cheer-leading squad? ... in which case they would have nixed the thing entirely.

But upon re-reading the article, we may pick out certain key phrases (emphasised in italics):

"He [the soldier interviewed] was one of dozens of Arabic speakers that played a key role in the allied ground attack against Iraq, and part of an attempt by the US Army to use finesse, intelligence work and tactics to complement brute strength."

If we fill in the missing blanks with such descriptions as "the megaphone was used to direct psychoacoustic frequencies that engaged the neural networks of the enemy's brain, causing him to think any thought and feel any emotion that the Americans chose to lay on him", then it starts to make sense. And it would no longer seem so surprising that one soldier could talk 450 enemy soldiers into surrendering. The possibilities are there, and, as the next article[5] documents, that is exactly what happened. Iraqi troops gave up en masse.

We quote: "They were surrendering in droves, almost too fast for us to keep up with..."; "...two Iraqi majors, both brigade commanders, who gave up their entire units..."; and "...one of them gave up to

Irrational? Not if there was also a voice being beamed into his head from that little flying toy, saying, "Give up, give up!" Otherwise, how do we account for the editor's note at the beginning of the article: "The following is based on pool dispatches that were subject to military censorship." Without that note, we could smugly think that the Iraqi soldiers were cowards or crazy, but why censor that idea?

MIND CONTROL WITH SILENT SOUNDS

The mind-altering mechanism is based on a subliminal carrier technology: the Silent Sound Spread Spectrum (SSSS), sometimes called "S-quad" or "Squad". It was developed by Dr Oliver Lowery of Norcross, Georgia, and is described in US Patent #5,159,703, "Silent Subliminal Presentation System", dated October 27, 1992. The abstract for the patent reads:

"A silent communications system in which nonaural carriers, in the very low or very high audio-frequency range or in the adjacent ultrasonic frequency spectrum are amplitude- or frequency-modulated with the desired intelligence and propagated acoustically or vibrationally, for inducement into the brain, typically through the use of loudspeakers, earphones, or piezoelectric transducers. The modulated carriers may be transmitted directly in real time or may be conveniently recorded and stored on mechanical, magnetic, or optical media for delayed or repeated transmission to the listener."

another computer and, at will, "silently induce and change the emotional state in a human being".

Silent Sounds, Inc. states that it is interested only in positive emotions, but the military is not so limited. That this is a US Department of Defense project is obvious.

Edward Tilton, President of Silent Sounds, Inc., says this about S-squad in a letter dated December 13, 1996:

"ALL schematics, however, have been classified by the US Government and we are not allowed to reveal the exact details... .. we make tapes and CDs for the German Government, even the former Soviet Union countries! ALL with the permission of the US State Department, of course... The system was used throughout Operation Desert Storm (Iraq) quite successfully."

The graphic illustration, "Induced Alpha to Theta Biofeedback Cluster Movement", which accompanies the literature, is labelled #AB 116-394-95 UNCLASSIFIED" and is an output from "the world's most versatile and most sensitive electroencephalograph (EEG) machine". It has a gain capability of 200,000, as compared to other EEG machines in use which have gain capability of approximately 50,000. It is software-driven by the "fastest of computers" using a noisenulling technology similar to that used by nuclear submarines for detecting small objects underwater at extreme range.[6]

The purpose of all this high technology is to plot and display a moving cluster of periodic brainwave signals. The illustration

(discounting normal left/right brain variations).

CLONING THE EMOTIONS

By using these computer-enhanced EEGs, scientists can identify and isolate the brain's low-amplitude "emotion signature clusters", synthesise them and store them on another computer. In other words, by studying the subtle characteristic brainwave patterns that occur when a subject experiences a particular emotion, scientists have been able to identify the concomitant brainwave pattern and can now duplicate it. "These clusters are then placed on the Silent Sound[™] carrier frequencies and will silently trigger the occurrence of the same basic emotion in another human being!"

[Up to Contents](#)

SYSTEM DELIVERY AND APPLICATIONS

There is a lot more involved here than a simple subliminal sound system. There are numerous patented technologies which can be piggybacked individually or collectively onto a carrier frequency to elicit all kinds of effects.

There appear to be two methods of delivery with the system. One is direct microwave induction into the brain of the subject, limited to short-range operations. The other, as described above, utilises ordinary radio and television carrier frequencies.

Far from necessarily being used as a weapon against a person, the

In more conventional use, the Silent Sounds Subliminal System might utilise voice commands, e.g., as an adjunct to security systems. Beneath the musical broadcast that you hear in stores and shopping malls may be a hidden message which exhorts against shoplifting. And while voice commands alone are powerful, when the subliminal presentation system carries cloned emotional signatures, the result is overwhelming.

Free-market uses for this technology are the common self-help tapes; positive affirmation, relaxation and meditation tapes; as well as methods to increase learning capabilities.

In a medical context, these systems can be used to great advantage to treat psychiatric and psychosomatic problems. As a system for remediating the profoundly deaf, it is unequalled. (Promises, promises. This is the most common positive use touted for this technology over the past 30 years. But the deaf are still deaf, and the military now has a weapon to use on unsuspecting people with perfectly normal hearing.)

OFFICIAL DENIALS

In fact, the US Government has denied or refused to comment on mindaltering weapons for years. Only last year, US News & World Report ran an article titled "Wonder Weapons", basically a review of the new so-called 'non-lethal' or 'less-than -lethal' weapons.' Not one word about S-quad, although the technology had been used six years earlier!

"Says Charles Bernard, a former Navy weapons-research director: 'I have yet to see one of these ray-gun things that actually works...'; and

DARPA (Defense Advanced Research Projects Agency) has come to us every few years to see if there are ways to incapacitate the central nervous system remotely,' Dr F. Terry Hambrecht, head of the Neural Prosthesis Program at NIH, told US News, 'but nothing has ever come of it,' he said. 'That is too science-fiction and far-fetched.'"

It may sound "science fiction and far-fetched" but it is not. However, that is just what the powers-that-be want you to believe, so as to leave them alone in their relentless pursuit of...what?

The idea behind non-lethal weapons is to incapacitate the enemy without actually killing them, or, in the case of riot control or hostage situations, to disable the participants without permanent injury, preferably without their knowing it. The electromagnetic mind-altering technologies would all fall into this class of weapons, but since they are all officially non-existent, who is to decide when and where they will be used?

And why should selected companies in the entertainment industry reportedly be allowed access to this technology when the very fact of its existence is denied to the general public?

As recently as last month [February], this stonewall approach of total denial or silence on the subject still held fast, even toward

convened on February 25, 1998 for the "Hearing on Radio Frequency Weapons and Proliferation: Potential Impact on the Economy".

Invited testimony included statements by several authorities from the military:

- Dr Alan Kehs, of the US Army Laboratories, discussed the overall RF threat.

- Mr James O'Bryon, Deputy Director of Operational Testing and Director of Live fire testing for the Office of Secretary of Defense at the Pentagon, discussed the role of Live Fire Testing and how it plays a role in testing military equipment with RF weapons.

- Mr David Schriener, Principal Engineer of Directed Energy Studies with Electronic Warfare Associates and recently retired as an engineer with a naval weapons testing facility, talked about the difficulty in building an RF weapon and about the terrorist threat.

- Dr Ira Merritt, Chief of Concepts Identification and Applications Analysis Division, Advanced Technology Directorate, Missile Defense and Space Technology Center, Huntsville, Alabama, discussed the proliferation of RF weapons primarily from the former Soviet Union.

Although these statements gave information of technical interest, they are perhaps more important for the information they did not give: information on the existence of radiofrequency weapons that directly affect the human brain and nervous system.

of development and denials of development-by the US Government and probably half of the other governments of the world as well.

We know that the former Soviet Union was actively engaged in this type of research. In a previous article we reported that during the 1970s the Soviet KGB developed a Psychotronic Influence System (PIS) that was used to turn soldiers into programmable 'human weapons'. The system employed a combination of highfrequency radiowaves and hypnosis. The PIS project was begun in response to a similar training scheme launched in the US by President Carter, according to Yuri Malin, former security adviser to USSR President Gorbachev.[8]

In my Electromagnetic Weapons Timeline[9] I covered a period of 60 years of interest and development in EM weapons-information gathered from the many articles and news clippings sent in by readers of Resonance. In my article on synthetic telepathy[10] I traced the development of the 'voice in your head' technology dating back to 1961, all my references coming from the open scientific literature.

POWER OF THE MILITARY-INDUSTRIAL COMPLEX

Jan Wiesemann has written an apt description of the situation which now exists in the United States, about the 'forces that be' and how the situation came about:

"During the Cold War the United States not only engaged in a relatively open nuclear arms race with the Soviet Union, but also

increase their power, so did the funds spent on developing techniques designed to outsmart each other.

"And as the US intelligence community began to grow, a secret culture sprang about which enabled the intelligence players to implement the various developed techniques to cleverly circumvent the democratic processes and institutions...

"Like many other democracies, the US Government is made up of two basic parts the elected constituency, i.e., the various governors, judges, congressmen and the President; and the unelected bureaucracies, as represented by the numerous federal agencies.

"In a well-balanced and correctly functioning democracy, the elected part of the government is in charge of its unelected bureaucratic part, giving the people a real voice in the agenda set by their government.

"While a significant part of the US Government no doubt follows this democratic principle, a considerable portion of the US Government operates in complete secrecy and follows its own unaccountable agenda which, unacknowledged, very often is quite different from the public agenda. "[11]

Jan goes on to quote one of the United States' most popular war heroes: Dwight D. Eisenhower, who served as Supreme Commander of Allied Forces during World War II and was later elected 34th President of the United States. In his farewell address to the nation in 1961, President Eisenhower said:

and women are directly engaged in the defence establishment. We annually spend on military security more than the net income of all United States corporations.

"This conjunction of an immense military establishment and a large arms industry is new in the American experience. The total influence-economic, political, even spiritual-is felt in every city, every state house, every office of the federal government. We recognise the imperative need for this development. Yet we must not fail to comprehend its grave implications. Our toil, resources and livelihood are all involved; so is the very structure of our society.

"In the councils of government, we must guard against the acquisition of unwarranted influence, whether sought or unsought, by the military -industrial complex. The potential for the disastrous rise of misplaced power exists and will persist. We must never let the weight of this combination endanger our liberties or our democratic processes."

INTERNATIONAL CONCERNS OVER NEW WEAPONS

The United Nations was established in 1945 with the aim of "saving succeeding generations from the scourge of war". In 1975 the General Assembly considered a draft first proposed by .the Soviet Union: "Prohibition of the Development and Manufacture of New Types of Weapons of Mass Destruction and New Systems of Such Weapons".

In 1979 the Soviet Union added a list of some types of potential

produce harmful effects similar to those of a nuclear explosion;

2) Particle beam weapons, based on charged or neutral particles, to affect biological targets;

3) Infrasonic acoustic radiation weapons;

4) Electromagnetic weapons operating at certain radio-frequency radiations which could have injurious effects on human organs.[12]

In response, the US and other Western nations stalled. They gave a long, convoluted reason, but the result was the same.

In an article entitled "Non-Lethal Weapons May Violate Treaties",[13] the author notes that the Certain Conventional Weapons Convention[14] covers many of the non-conventional weapons—"those that utilize infrasound or electromagnetic energy (including lasers, microwave or radiofrequency radiation, or visible light pulsed at brainwave frequency) for their effects".

Harlan Girard, Managing Director of the International Committee Against Offensive Microwave Weapons, told me he believes the strategy behind the government's recent push for less-than-lethal weapons is a subterfuge. The ones that are now getting all the publicity are put up for scrutiny to get the public's approval. The electromagnetic mind-altering technologies are not mentioned, but would be brought in later under the umbrella of less-than-lethal weapons.

weapons of this nature from being used in international warfare.

In other words, weapons that are barred from use against our country's worst enemies (notwithstanding the fact that the US did use this weapon against Iraqi troops!) can now be used against our own citizens by the local police departments against such groups as peaceful protestors of US nuclear policies.

TOWARDS GLOBAL MIND CONTROL

The secrecy involved in the development of the electromagnetic mind-altering technology reflects the tremendous power that is inherent in it. To put it bluntly, whoever controls this technology can control the minds of men-all men.

There is evidence that the US Government has plans to extend the range of this technology to envelop all peoples, all countries. This can be accomplished, is being accomplished, by utilising the nearly completed HAARP project[15,16] for overseas areas and the GWEN network now in place in the US. The US Government denies all this.

Dr Michael Persinger is a Professor of Psychology and Neuroscience at Laurentian University, Ontario, Canada. You have met him before in the pages of Resonance where we reported on his findings that strong electromagnetic fields can affect a person's brain.

"Temporal lobe stimulation," he said, "can evoke the feeling of a presence, disorientation, and perceptual irregularities. It can

Dr Persinger wrote an article a few years ago, titled "On the Possibility of Directly Accessing Every Human Brain by Electromagnetic Induction of Fundamental Algorithms".[18] The abstract reads:

"Contemporary neuroscience suggests the existence of fundamental algorithms by which all sensory transduction is translated into an intrinsic, brain-specific code. Direct stimulation of these codes within the human temporal or limbic cortices by applied electromagnetic patterns may require energy levels which are within the range of both geomagnetic activity and contemporary communication networks. A process which is coupled to the narrow band of brain temperature could allow all normal human brains to be affected by a subharmonic whose frequency range at about 10 Hz would only vary by 0. 1 Hz."

He concludes the article with this:

"Within the last two decades a potential has emerged which was improbable, but which is now marginally feasible. This potential is the technical capability to influence directly the major portion of the approximately six billion brains of the human species, without mediation through classical sensory modalities, by generating neural information within a physical medium within which all members of the species are immersed.

"The historical emergence of such possibilities, which have ranged from gunpowder to atomic fission, have resulted in major changes in the social evolution that occurred inordinately quickly after the

the scientific and public domain."

It doesn't get any plainer than that. And we do not have open discussion because the US Government has totally denied the existence of this technology.

Acknowledgements

I would like to give special thanks to: Jan Wiesemann for sending the Silent Sounds[™] statement and patents which were the keystone of this article; Mike Coyle, whose computer search turned up many more related patents; Harlan Girard, who has provided numerous official government documents; and to the many who have provided newsclippings and articles, moral and financial support to Resonance, without which we'd have ceased publication long ago.

About the Author:

Judy Wall is Editor and Publisher of Resonance, the Newsletter of the MENSA Bioelectromagnetics Special Interest Group. pp.11--13,15-16

[Up to Contents](#)

APPENDIX US2 ... ULTRASONIC MIND CONTROL COMMON, UNCLASSIFIED

AERIAL MIND CONTROL

The Threat to Civil Liberties

by Judy Wall, Editor/Publisher RESONANCE

Newsletter of the MENSA Bioelectromagnetics Special Interest Group

Judy Wall can be contacted by mail at:

Judy Wall, Editor/Publisher

RESONANCE

684 County Road 535

Sumterville FL

USA 33585

Eleanor White's comments: This hard hitting article by Judy Wall, who is NOT a mind control victim and in fact avoids victim testimonials in favour of only factual objective material, contains some POWERFUL items not widely known among involuntary mind control experimentees.

The most important facet of this article is that Judy Wall presents evidence unknown to most of the public IN SPITE OF ITS BEING UN-CLASSIFIED, and in the public domain for the past two decades.

The main technology used is a mix of ultrasonic voice or brain entrainment, mixed with microwave voice-to-skull or ordinary radio and TV signals, described in detail in Appendix US1:

US1.....SILENT SOUND, BRITISH ITV & NEXUS MAGAZINE

The microwave voice-to-skull technology is described in the 1974 article from American Psychologist magazine, Appendix PM6:

PM6.....DR. DON R. JUSTESEN'S REPORT: 1974 VOICE TO SKULL SUCCESS

.....

civilian population as well as enemy troops. Some of these actions against civilians are done with the intent of influencing public opinion and the outcome of elections.

In a previous article, we examined mind-control technology, especially that utilizing Silent Sound [TM], in which radio-frequency broadcasts carry subliminal patterns that entrain the listener's brainwaves into a pre-selected emotional state. According to ITV wire service reports, this technology was used during Operation Desert Storm in 1991, as part of the US Psychological Operations (PsyOps) directed against Iraqi troops. [1,2]

To the Desert Storm offensive we can now add several other incidents. Alex Horvat, editor of The Probe, calls to our attention the 1998 video, Exotic Weapons of Mass Control, produced by Bob Fletcher.

"The excerpt played on Fletcher's video is from TLC (The Learning Channel) and clearly states that Commando Solo was used in Haiti for what was called Operation Uphold Democracy. As the general populace was violently opposed to Aristide and most in favor of his ouster, it took nearly a year of this clandestine counter-programming to get them to change their minds. Instead of butchering a population physically, we can no manipulate them mentally, virtually enslaving their thoughts with a criss-cross pattern of flights by an EC-130 (which is just a C-130 heavily laden with electronic hardware.) [3]

We were not at war with the citizens of Haiti, yet the U.S. Government directed military weapons against this friendly, or at least neutral, civilian population. The U.S. Government sanction the "rigging" of the Haitian election by mental control of the people, programming them to cast

Government doing this? Who is behind this flagrant violation of civil liberties? Is it the U.S. Central Intelligence Agency (CIA) which has a long history of interfering in foreign government politics? Or has this become standard military procedure?

The rationale is always the same: "to make the world safe for democracy". Yet what is democracy if not freedom? Freedom to think your own thoughts; freedom to express your own opinions; freedom to vote for the candidate of your own choice.

Fletcher's video also mentions that the same technology was used against the Bosnia population for a week to influence their election. [4] This was probably done during Operation Joint Guard in 1995. [5]

The questions arise: If they have used mind-control broadcasts against foreign civilian populations to influence elections, will they use them against American citizens -- or have they already? What other countries may be the recipients of this innovative technology?

Just what is this EC-130E Commando Solo? The United States Air Force has helpfully published a fact sheet that describes the Lockheed built aircraft. [6] This 1995 bulletin states that the "unit flyaway cost" is more than US \$100 million each, and that there are eight in the inventory. Its primary function is "Psychological operations broadcasts". The crew consists of four officers (pilot, copilot, navigator, control chief/EWO) and seven enlisted members (flight engineer, loadmaster, five mission crew.)

According to the fact sheet:

military communications bands. Missions are flown at maximum altitudes possible to ensure optimum propagation patterns. The EC-130 flies during either day or night scenarios with equal success, and is air refueable. A typical mission consists of a single ship orbit which is offset from the desired target audience. The targets may be either military or civilian personnel.

"Secondary missions include command and control communications counter-measures (C3CM) and limited intelligence gathering.

"Air Force Features: Highly specialized modifications have been made to the latest version of the EC-130. Included in these modifications are enhanced navigation systems, self-protection equipment, and the capability of broadcasting color television on a multitude of world-wide standards throughout the TV VHF/UHF ranges.

"Air Force Background: Air National Guard EC-130 aircraft flown by the 193rd Special Operations Group were deployed to both Saudi Arabia and Turkey in support of Desert Storm. Their missions included broadcasts of 'Voice of the Gulf' and other programs intended to convince Iraqi soldiers to surrender.

"The EC-130 was originally modified using the mission electronic equipment from the EC-121, known at the time as the Coronet Solo. Soon after the 193rd SOG received its EC-130s, the unit participated in the rescue of US citizens in Operation Urgent Fury, acting as an airborne radio station informing those people on Granada of the US military action.

"Volant Solo, as the mission is now known, was instrumental in the success

Operation Just Cause? this is another propaganda name, applied to the U.S. invasion of Panama to take out that country's Leader, General Noreiga, the CIA's erstwhile partner in drug smuggling. Apparently the General had made someone mad -- how else to account for the massive invasion of this tiny tourist country? To wit: "A superpower whipped the poop out of 10 percent of the police force of a Third World nation. You are supposed to be able to do that. It was done well, and I credit those who did it. But it is important that we draw the right lessons from it" according to an anonymous US Marine. [7]

Our Commander-in-Chief had another point of view: "...the roll call of glory, the roster of great American campaigns -- Yorktown, Gettysburg, Normandy, and now Panama."

--President George Bush, March 1990 [8]

MILITARY PSYOPS AGAINST CIVILIANS

In a phone call to the USAF Special Operations Command Public Affairs Office, I questioned the legitimacy of using these subliminal broadcasts against civilian populations. [9]

[Judy Wall's article on [Silent Sound](#) for details.]

I was told that it was all perfectly legal, having been approved by the U.S. Congress (!). It may be okay by Congress, but I sincerely doubt that it would be approved by the recipient populations.

That conversation also elicited more information concerning the Commando Solo units. For instance, the Air National Guard

*technology can be directed against
U.S. citizens.*

*The Commando Solo aircraft have participated in the following missions--
possibly more, as the early missions of Volant Solo 1 were not known to
this spokesperson:*

- Operation Urgent Fury (Grenada, Oct-Nov 1983, Jan-Jun 1985)*
- Operation Just Cause (Panama, Late December 1989)*
- Operation Desert Shield (Kuwait, Iraq, from August 1990)*
- Operation Desert Storm (Saudi Arabia, Turkey, Iraq, 1991)*
- Operation Uphold Democracy (Haiti, 1994-1995)*
- Operation Joint Guard (Part of a UN operation in
Bosnia-Herzegovina, 1995)*
- Operation Desert Thunder (part of a UN operation in Iraq)*
- Operation Desert Fox (Iraq, 2 to 3 days in December 1998)*

*Other countries are known to have a similar aircraft, but the PR officer
declined to identify them, suggesting that I check out Jane's Defence
Weekly for such information. Not having access to that particular
publication, I searched through my copy of Jane's Radar and Electronic
Warfare Systems 1993094. [10] The Commando Solo unit was not listed,
but a browse through the book was informative as to the numerous types of
electronic offence and defence systems available. These include sta-
tionary and mobile land units (many housed in large trucks), shipboard and
airborne models as well as well as space-based technology. If the military
is spending US \$100 million per airborne unit (times eight, we're talking
US \$800 million here), I think it is safe to assume that they have tried
out mind control equipment with less expensive, roving land units (trucks),*

And I might add, we can assume that they have tried out the efficacy of this mind-control technology. Even the US military would not waste \$800 million on something unless it has been proven to work, and work effectively, even under the adverse situation of military combat. This is an important point.

The initial research into mind control in the USA was conducted under the auspices of the CIA. The flagrant abuse of human rights in experimenting on unsuspecting persons was based on the supposition that the veracity of experiments would be compromised if a subject knew that he was participating in an experiment. In the case of mind-control technology, this supposition might very well be true. But that does not justify its use -- or so said the Nuremberg Code, the tenets of which were used as a legal basis to prosecute Nazi scientists for war crimes. However the US seems to have excused its own military and scientific community from adhering to that Code. [11]

MANIPULATING MIND AND BODY BY SATELLITE

The next logical step in mind control would be to incorporate this technology into satellite communications. Since other countries are known to have similar capabilities, there could occur a situation in which electronic mind control warfare is waged against a civilian population, receiving conflicting mental manipulation from both sides. What would be the mental state of individuals so targeted? Would it cause a rise in mental aberrations and schizophrenia? And what are the limits of mind manipulations? Can people be forced to commit suicide? Can physical ailments or psychosomatic illnesses be induced?

skin problems for which doctors could find no physical cause. [12]

It is not a far step from manipulating a person's emotional state to influencing bodily functions. Indeed, much of the literature on documenting microwave effects on biological systems deals with precisely this phenomenon. In fact, studies of the physical effects of microwave exposure (including radio frequencies) generally preceeded studies of mental effects.

A meeting sponsored by Defense & Foreign Affairs and the International Strategic Studies Association was held in Washington DC in 1983. High-Level officials from many countries met for this conference. They discussed psychological strategies related to government and policymaking. A summary of the agenda reads: "The group will be discussing the essence of future policymaking, for it msut be increasingly clear to all that the most effective tool of government and strategy is the mind... If it's any consolation to the weapons-oriented among defense policymakers, the new technologies of communications -- satelllites, television, radio, and mind-control beams -- are 'systems' which are more tangible than the more philosophically based psychological strategies and operations.

[Eleanor White's comment: Anyone know where to get a copy?]

"But we should make no mistake; it will be the 'psychologically based' systems which determine the world's fate in coming years: the condition of the minds of populations and leaders. And we should not ignore the fact that the USSR [this was in 1983] is working on electronic systems to 'beam' messages directly into the brain. What good, then, are conventional systems if these types of weapons are not countered? And, on a more basic level, what good is a weapon system if public opinion or political con-

public does not know about a weapon system, it cannot prohibit its deployment. This is the situation that applies to mind-control technology.

MIND CONTROL AGAINST 'POTENTIAL' ENEMIES

The US military is aware that certain actions or procedures may not be acceptable to the American public. Metz and Kievit express these concerns in their paper, "The Revolution in Military Affairs and Short Conflict War."

[14] "The use of new technology may also run counter to basic American values. Information age -- and in particular, information warfare -- technologies cause concerns about privacy... American values also make the use of directed-energy weapons ... morally difficult, perhaps unacceptable. The advantage of directed-energy weapons over conventional ones is deniability.

"Against whom is such deniability aimed? ... deniability must be aimed at the American people."

Later they state: "We must decide whether innovative military capabilities are, in fact, acceptable and desirable. That can only happen through open debate. The military must be a vital participant, but not the sole one."

But there has been no open debate.

On July 21, 1994, the US Department of Defense proposed that non-lethal weapons be used not only against declared enemies, but against anyone engaged in activities that the DOD opposed. That could include almost anybody and anything. Note that the mind-control technology is classified under non-lethal weapons. [15]

and believe things that do not exist" and that "The same idea was contained in a 15-volume study by the USAF Scientific Advisory Board, issued in 1996, on how to maintain US air and space superiority on the battlefields of the 21st century". [16,17]

It seems that, in military parlance, a "prediction" means: "Don't be surprised when you find out we've already got this, but it's classified and we can't admit to it just yet."

Notice that General Jumper predicts that mind control technology will be used against potential enemies. The military and government agencies may apply this term to any group or individual they perceive as a threat to their own interests. Potential enemies may be counter-culture individuals, those of opposing political viewpoints, economic or financial competitors, biological undesirables, etc. It is part of the military agenda to identify potential threats so as to be prepared to meet them. Experience has shown that the US Government (the CIA and FBI, for example) has moved against these people or groups, slandering, harassing, even killing them, without adequate cause or legal sanction.

A weapon that can be used in secret lends itself to abuse by unethical individuals in positions of power. The military and secret services have shown themselves often to be lacking in ethical constraints. After all, the job of the military is war; it is killing people; and so, just how this is accomplished may be considered irrelevant. Lesser evils, like mind control, pale by comparison.

Of course, it can be argued that it is far more humane to brainwash a person via mind control technology than it is to torture or kill them.

EUROPEAN PARLIAMENT WARNS OF DANGERS

Awareness of the existence of mind-control technology, and hence its dangers and possibility for misuse, seems to be more prevalent than in Europe than in other areas. The European Parliament recently passed a "Resolution on environment, security, and foreign policy". [18] This document includes these articles:

"23. Calls on the European Union to seek to have the new 'non-lethal' weapons technology and the development of new arms strategies also covered and regulated by international conventions...

"27. Calls for an international convention introducing a global ban on all developments and deployments of weapons which might enable any form of manipulation of human beings."

The United States will ignore these resolutions, of course, as it has other EP requests; for example, as mentioned in the same document:

"24. Considers HAARP (High Frequency Active Auroral Research Project) by virtue of its far-reaching impact on the environment to be a global concern and calls for it's legal, ecological and ethical implcations to be examined by an international independent body before any further research and testing; regrets the repeated refusal of the United States Administration to send anyone in person to give evidence to the public hearing or any subsequent meeting to be held by its competent committee into the environmental and public risks connected with the HAARP programme currently being funded in Alaska..."

replace the existing Extremely Low Frequency (ELF) submarine communications system now operating in Michigan and Wisconsin; (2) to provide a way to wipe out communications over an extremely large area, while keeping the military's own communications system working. [19]

As we have seen, the mind-control subliminal messages are carried on radio-frequency broadcasts.

[Judy Wall's article on [Silent Sound](#) for details.]

The HAARP facility could be used to broadcast global mind-control messages, or such messages could simply be inserted into existing systems.

Dr. Igor Smirnov, of the Institute of Psycho-correction in Moscow, says in regard to this technology: "It is easily conceivable that some Russian 'Satan', or let's say Iranian [or any other 'Satan'], as long as he owns the appropriate means and finances, can inject himself [intrude] into every conceivable computer network, into every conceivable radio or television broadcast, with relative technological ease, even without disconnecting cables.

You can intercept the [radio] waves in the aether and then [subliminally] modulate every conceivable suggestion into it. If this transpires over a long enough time period, it accumulates in the heads of people. And eventually they can be artificially manipulated with other additional measurements, to do that which this perpetrator wants [them to do]. This is why [such technology] is rightfully feared." [20]

A WORLDWIDE MIND CONTROL MISSION

aircraft is consistently improving its capabilities.

The next few years should see continued enhancements to the EC-130 and its worldwide mission."

About the Author:

Judy Wall is the Editor of RESONANCE, the newsletter of the Bioelectromagnetics Special Interest Group of American MENSA Ltd. Viewpoints expressed here are her own personal views.

ENDNOTES

1. *Wall, Judy, "Military Use of Mind Control Weapons", NEXUS, 5/06, Oct-Nov 1998*
 2. *"Psychological operations" are defined as:
"Planned operations to convey selected information and indicators to foreign audiences to influence their emotions, motives, objective reasoning, and ultimately the behavior of foreign governments, organizations, groups and individuals. The purpose of psychological operations is to induce or re-inforce foreign attitudes and behavior favorable to the originator's objectives. Also called PsyOps." From "Joint Doctrine for Information Operations", Joint publication 3-13, 9 October 1998. Thanks to Harlan Girard of the International Committee on Offensive Microwave Weapons (PO Box 58700, Philadelphia PA 19102-8700, USA) for the excerpt.*
 3. *Horvat, Alex, "Commando Solo", The Probe, vol. 4,*
-

video available from The Probe (see above) or Global Insights, A675 Fairview Dr. #246, Carson City NV, 89701 USA, tel 1-800-729-4131.

5. *An item of interest is that the US had a new type of aerial reconnaissance plane positioned over the former Yugoslavia from July 14, 1995, about six months before the US officially intervened. The 10-million-dollar unmanned saucer-shaped spy craft is nicknamed "Dark Star". Information from C-Com (Classified Communications 3(12), Dec 1995; Erich A. Aggen, Jr., (editor), citing CE Chronicles nos. 1 and 2 and Raising Awareness newsletter.*
 6. *Fact Sheet, dated March 1995. The address on the publication is AF Special Operations Command Public Affairs Office, 100 Bartley Street, Hurlburt Field, FL 32544-5273, USA. They no longer supply printed copies, but you can access the document at <http://www.hurlburt.af.mil>*
 7. *Morrison Taw, Jennifer, "Operation Just Cause: Lessons For Operations Other Than War", Rand Corp., 1996, p. vii; quoting from "Some Questions Whether the US Is Ready for LIC", Navy News and Undersea Technology, August 27, 1990, p.7.*
 8. *Morrison Taw, Jennifer, ibid., p.1.*
 9. *Telephone conversation of February 26, 1999, with AF Special Operations Command Public Affairs Office; voice (850) 884-5515, email paprhode@hqafsoc.afoc.af.mil*
 10. *Blake, Bernard (ed.) Jane's Radar and Electronic Warfare Systems 1993-94, Jane's Information Group*
-

CR5 2NH, UK.

11. (a) *"US Nullifies Nuremburg Law"*, *Earth Island Journal*, Winter 1996-97. (b) Hightower, Jim, *"Unregulated Experiments on Humans"*, *New Times*, June 19-25, 1997; cites Stolberg, Sheryl Gay, *"Unchecked Research People Raises Concern on Medical Ethics"*, *New York Times*, May 14, 1997. (c) See *"Ban on Medical Experiments Without Consent is Relaxed"*, *New York Times*, November 5, 1996, p.1; copy available for 50 cents from David Park Brooks, 3456 17th St., San Francisco CA 94110. (d) Also see Senator John Glenn's bill S-193, *"Human Subjects Research Protection Act of 1997"*, *Congressional Record, US Senate*, January 22, 1997. (e) *"In 1994, a congressional subcommittee found up to 500,000 Americans between 1940 and 1974 were endangered by secret defense-related tests including radiation experiments, mustard gas, LSD and biological agents."* See *Pitch Weekly*, April 17-23, 1997.
 12. Schaefer, Paul, *"Experimentation and Warfare"*, article citing *The Kansas City Star*, between March 25 and 31, 1990.
 13. Summary, *The Perth Corporation, Defense & Foreign Affairs*, November 1983.
 14. Metz, Steven, and James Kievit, *"The Revolution in Military Affairs and Conflict Short of War"*, *US Army War College, Carlisle Barracks, PA 17013-5050, USA*, pp. 15-16 and 29. [See also Krawczyk, Glenn, *"Big Brother's Recipe for 'Revolution in Military Affairs'"*, *NEXUS* 2/26, June-July 1995.]
-

16. *"Microwave Weapons", Microwave News, March/April 1998; Louis Slesin (editor), citing Aviation Week, March 9, 1998.*
17. *Same article as above, citing Microwave News, January/February 1997.*
18. *"Environment, Security, and Foreign Affairs", Resolution A40005/99, Minutes of 28/01/99 - Provisional Edition, European Parliament. For copy, thanks to Grattan Healy, Advisor on Energy & Research, Green Group in the European Parliament, LEO 2C35, Rue Wiertz Straat, B-1047 Bruxelles, Belgium, email ghealy@europarl.eu.int*
19. *For more info on HAARP, see Begich, Nick and Jeanne Manning, Angels Don't Play This HAARP, Earthpulse Press, PO Box 201393, Anchorage AK 99520, USA, Tel. (907) 249-9111.*
20. *From a German documentary, "Geheimes Russland: Moskau - Die Zombies dr roten Zaren" ("Secret Russia: Moscow - The Zombies of the Red Czars") aired on German TV network ZDF on December 22, 1998. Script translation by Jan Weisemann. The full text is to be published in Resonance, No. 35.*
21. *Reed, Chris, Lockheed C-130 Hercules and Its Variants, Schiffer Publishing Ltd, Atglen, PA, 1999.*

[Up to Contents](#)

APPENDIX US3 ... U.S. ARMY ULTRASOUND WEAPON PROJECT

TOPIC NUMBER: A97-003

SYNETICS Corporation <http://www.synetics.com>

CORPORATE OFFICIAL:

George D. Hughes Jr.

PHONE:

540-663-2137

TITLE:

Parametric Difference Waves for Low Frequency Acoustic Propagation

ABSTRACT/BENEFITS:

Prior research indicates that an array of ultrasonic sources operated with an offset in frequency will produce infrasonic or very low frequency energy. This energy is useful because it is omni-directional, and it propagates well with little absorption. With sufficient energy, the resulting infrasonic waves can be disabling or lethal. Synetics proposes an approach toward developing infrasonic waves that can ultimately be incorporated into future man-portable small arms weapon systems. This approach utilizes modernized pneumatic technology which produces an extremely high-powered ultrasonic source. The resulting frequency generated is precisely controlled such that the desired high power infrasound frequency can be generated at the target by beating two focused ultrasonic sources.

BENEFITS:

The potential post applications of the parametric difference wave

KEYWORDS:**INFRASOUND GENERATION ULTRASONIC TUNING****ACOUSTIC WEAPON ULTRASONIC HIGH POWER**[Up to Contents](#)

APPENDIX US4 ... SILENT HYPNOSIS, VOICE-FM COMMERCIAL METHOD

Altered States Ltd commercial site clearly demonstrates the very thin line between "subliminal learning" using "Voice FM", and "silent hypnosis" as experienced by involuntary experimentees.

The reader is invited to scan the sample phrases from these so-called "learning tapes". Whether it's "learning" or "hypnosis" is left for the reader to decide.

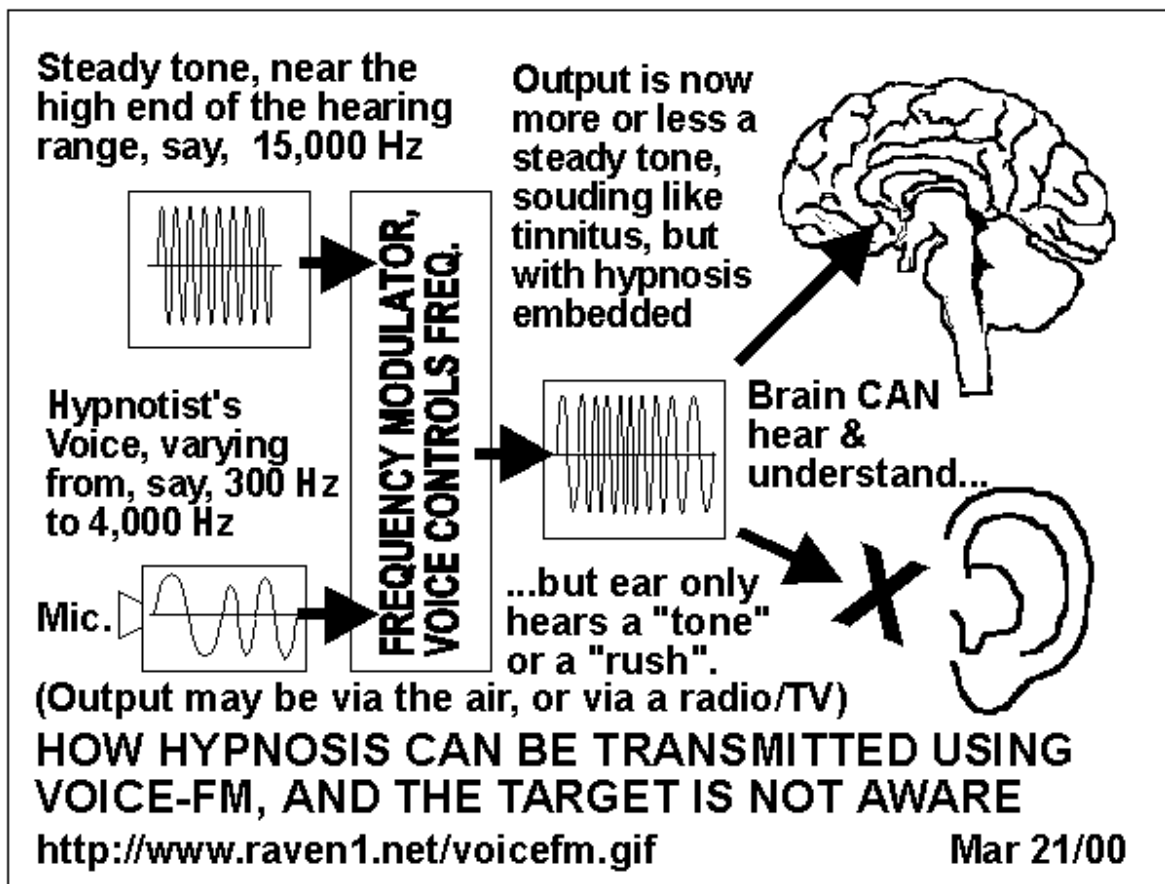

Image shows how voice is transformed to an inaudible signal.

ALTERED STATES LTD

Ph: +64-9-815-5095 or +64-9-815-5059

Fax: +64-9-815-5067

Email: altered@ihug.co.nz

Postal address:

P.O.Box 68-344, Newton,

Auckland, New Zealand.

Street address:

6A Western Springs Rd,

Morningside Auckland

The original commerical link from which the text below was copied on March 22, 2000 is:

<http://www.altered-states.co.nz/cgi-bin/reload.cgi?^/sub/silent.htm>

SILENT SUBLIMINALS

Only your mind can hear. Your ears hear nothing but your mind hears and accepts the powerful suggestions.

You can safely play these tapes anywhere - in a car, while watching TV or listening to your favorite music, while working or even as silent sleep programming.

Warning: Everyone within listening range of the tape will be programmed by the suggestions. To assure yourself that strong suggestions are recorded on the tape, take it to any Radio Shack store, play it on their stereo and read the output with a Radio Shack Sound Level Meter (Item 33-2050)

How To Use The Tapes: Increase the volume until it is just below any tape noise. If your stereo deck has treble and bass controls, you can boost the subliminal output by increasing the treble and decreasing the bass. The player then emits a strong but inaudible frequency - modulated 60 - 90 decibel signal that is received and demodulated by the human ear.

Technical Information The Suggestions are delivered on a carrier frequency of 14,800 cps, via a low-distortion sinewave signal. This frequency is slightly above the audible hearing range but the frequency-modulated (FM) signal is still strongly impinging upon the diaphragm of the ear. The listener

[EW: Note the similarity to Lowery patent, [US 5,159,703](#)]

How To Use The Tapes: Increase the volume until it is just below any tape noise. If your stereo deck has treble and bass controls, you can boost the subliminal output by increasing the treble and decreasing the bass. The player then emits a STRONG BUT INAUDIBLE frequency-modulated 60 to 90 decibel signal that is received and demodulated by the human ear.

The Silent Subliminals is a new brain / mind technology developed by an aerospace engineer. This new technique has been licensed to Valley of the Sun Audio /

Video for this incredible new tape series. Patent pending.

Note: Because the frequency is beyond normal recording range, the tape cannot be duplicated:

Examples of Suggestions:

- "Every day you become thinner and thinner"
 - "You now lose weight and full fill your goals"
 - "You attain your weight goals and the body you desire"
 - "You have the power and ability to attain the perfect weight and body you desire"
 - "You have the self-discipline to lose all the weight you want"
 - "You live a healthy lifestyle and eat a proper diet"
 - "You now quit smoking because it serves you"
 - "You lose all desire to smoke"
 - "You accept that you now quit smoking"
 - "You are a non-smoker"
 - "Quit smoking. Quit smoking. Quit smoking"
 - "You have the willpower to do anything you want to do"
 - "You have great self- discipline and you use it to quit smoking"
 - "Cigarettes disgust you"
 - "You are very sure of yourself"
 - "You accept that you have great inner courage"
 - "You are self-reliant and self-confident"
 - "You are full of independence and determination"
-

- *"You are relaxed and at ease"*
- *"You detach from worldly pressures and experience an inner calm"*
- *"Negativity flows through you without affecting you"*
- *"You accept other people as they are"*
- *"You peacefully accept the things you cannot change, and change the things you can"*
- *"You are at peace with yourself, the world and everyone in it"*
- *"Your mind is like calm water"*
- *"You direct your time and energy to manifest your desires"*
- *"You have the self-discipline to accomplish your personal and professional goals"*
- *"Every day, you increase your self-discipline"*
- *"You do what you need to do and stop doing what doesn't work"*
- *"You freely choose to do what you need to do"*
- *"You are assertive and feel good about yourself"*
- *"You now focus your energy upon attaining success"*
- *"You know exactly what you want and you go for it"*
- *"You can accomplish whatever you set out to do"*
- *"Be ultra-successful. Be ultra-successful and become wealthy"*
- *"Every day in every way, you become more successful"*
- *"Your creative thinking opens the door to monetary abundance"*
- *"You easily achieve and maintain a penile erection"*
- *"Your body performs perfectly during sex without thinking about it"*
- *"A hard, firm erection is your natural response to sexual stimulation "*
- *"You can make love for a long before you ejaculate"*
- *"Every day you feel better about your sexual prowess and your ability to achieve and maintain a hard, firm erection"*

[Up to Contents](#)

US5....."ACOUSTIC SPOTLIGHT" CAN TARGET ONE PERSON IN CROWD

THIS IS THE TEXT PORTION ONLY OF THE ORIGINAL WEB PAGE

POSTED BY F. JOSEPH POMPEII, MIT MEDIA LAB. The image

ONE SIGNAL IS PURE 200.0 KHZ SOUND

NO AUDIBLE SOUND EMANATES FROM HERE

TWO 200 kHz AIR TYPE ULTRA SOUND TRANSDUCERS

ALL AUDIBLE SOUND COMES FROM POINT OF IMPACT WHICH MAY BE A LIVING THING - PERSON, BIRD, ETC.

UP TO SEVERAL HUNDRED FEET

OTHER SIGNAL IS NOMINAL 200 kHz BUT IS FREQUENCY MODULATED BY VOICE OR OTHER AUDIBLE RANGE INPUT

** CAN ALSO CARRY ULTRA SONIC HYPNOSIS, RESULTING IN UNDETECTABLE HYPNOTIC EFFECTS

ACOUSTIC HETERODYNE
AMERICAN TECHNOLOGIES CORP.
13114 Evening Creek Dr. S.
San Diego, CA 92128

[Http://home.nas.net/~naven1](http://home.nas.net/~naven1)

The ORIGINAL LINK FOR THIS PAGE (As of March 22, 2000):

<http://sound.media.mit.edu/~pompei/spotlight/>

Machine Listening Group Digital Life Consortium

A beam of light can be controlled in many ways - it can be aimed at one person in a crowd, spread to fill a room, or projected to create rich, distant imagery.

To my friends in the UK:

Thanks to those who have contacted me regarding the BBC piece; I'm happy it was so well received. I recently had a very polite British visitor, who seemed to enjoy the demonstration a great deal... click the photo to see who it was.

The Audio SpotlightTM, invented and developed at the MIT Media Lab, is a device which uses subtle nonlinear properties of the air to create an extremely narrow Sound BeamTM. This beam of sound behaves just like a beam of light - 'shining' it at a specific listener allows only that person to hear it, and projecting it against a surface creates an acoustic 'image' at the point of reflection. It is the first device that provides total control over both the location and distribution of high quality sound, something impossible to achieve with traditional loudspeakers.

The circular transducer is very thin, and can be constructed in a variety of sizes and configurations as needed. A typical Audio Spotlight transducer has an active area of approximately 1 foot diameter, and, depending on size and frequency content, projects an approximately three-degree wide beam of sound audible to well over 100 meters. Harmonic distortion has been reduced to close to that of a traditional loudspeaker, sound level is quite appreciable (on the order of 80-90dBA) at several meters, and frequency response, depending on size, extends down to a few hundred Hertz, and upwards beyond the range of hearing. Continued research is being conducted on all

the device in collaboration with several of our Media Lab Sponsors in preparation for eventual commercial release.

Put sound wherever you want it.TM

F. Joseph Pompei pompei@media.mit.edu

Usage

The Audio Spotlight can be used in two major ways: As directed audio, sound is directed at a specific listener or area, to provide a private or area specific listening space. As projected audio, sound is projected against a distant object, creating an audio image. This audio image is literally a projected loudspeaker - sound appears to come directly from the projection, just like light.

The Audio Spotlight consists of a thin, circular transducer array and a specially designed signal processor and amplifier. The transducer is about half an inch thick, nonmagnetic, and lightweight. The signal processor and amplifier are integrated into a unit about the same size as a traditional audio amplifier, and has similar power requirements.

Technology

Because it is impossible to generate extremely narrow beams of audible sound without extremely large loudspeaker arrays, we instead generate the sound indirectly, using the nonlinearity

The device transmits a narrow beam of ultrasound (blue), which, due to the inherent nonlinearity of the air itself, distorts (changes shape) very slightly as it travels. This distortion creates, along with new ultrasonic frequencies, audible artifacts (green) which can be mathematically predicted, and therefore controlled. By constructing the proper ultrasonic beam, this nonlinearity can be used to create, within the beam itself, an audible sound beam containing any sound desired. This is presently done in real-time using low cost circuitry, a specially designed amplifier, and transducers developed at MIT specifically for this project.

Hyperdirectivity

The directivity, or narrowness, of an acoustic wave generated by a circular transducer is proportional to the ratio of the diameter of the transducer to the wavelength of the sound. So a transducer much larger than the wavelength of the sound creates a very narrow beam.

Audible sound contains wavelengths reaching lengths of several feet, so a reasonably sized loudspeaker will always produce a very wide, non-directional source at lower frequencies. The Audio Spotlight, in contrast, outputs short, millimeter sized ultrasonic waves, which form a very narrow beam even in a small transducer, which in turn generates audible sound. The nature of the nonlinear transformation also essentially eliminates sidelobes in the resulting beam, and maintains

The figure to the right compares the directivity of the Audio Spotlight (yellow) to that of an ordinary Loudspeaker (purple).at 400 Hz. Note that the directivity of the Audio Spotlight is only three degrees, compared to the essentially omnidirectional directivity of the Loudspeaker.

In order to obtain such narrow directivity from a traditional Loudspeaker system, one would need a Loudspeaker array fifty meters across!

A Loudspeaker is like a light bulb, but the Audio Spotlight is like a laser.

History

The use of nonlinear interaction of high frequency sound to generate directive low frequency sound sources has been a well researched subject in the field of underwater acoustics since the early 1960's. Often misattributed to so-called "Tartini Tones", the effect is more accurately described as a parametric array, a term introduced by Westervelt [1]. In the past several decades, many underwater sonar researchers have used the effect to both generate directive low frequency sonar beams, detect underwater sound (parametric receiving array), and extend the bandwidth of underwater transducers.

The first published demonstration of an airborne parametric array was in 1975 by Bennett and Blackstock [2]. Rather than using inaudible ultrasound, they instead used very intense,

parametric array would work in air in addition to underwater.

In the early 1980's, several Japanese companies, such as Nippon Columbia, Ricoh, and Matsushita, attempted to develop the parametric array for the reproduction of broadband audible sound. They typically deployed large arrays containing hundreds of piezoelectric transducers, such as the one to the right [3], to transmit simple AM modulated audible signals. While successful in reproducing sound, tremendous problems with cost, robustness, and extremely poor sound quality (up to 50% total harmonic distortion) caused them to abandon the technology as unfeasible.

More recently in mid 1996, an American company produced their own version of this device and proclaimed it 'a revolution' in audio. In fact, this device, contrary to their claims and unbeknownst to the popular press, was very similar to those described in audio journals a decade earlier (shown to the left), and of course suffered from the very same problems of poor sound quality and lack of robustness that plagued the earlier researchers [4]. Since then, there has been no published evidence of progress towards a practical device.

Background

Since his days as a part-time musician and young acoustics engineer at Bose in the early 1990's, Mr. Pompei recognized that a key ingredient missing from audio reproduction was the ability to reliably spatialize sound. While in a natural

very vague and limited spatial impression. Similarly, what was missing from music, he decided, was the ability to choreograph musical instruments in space, just as you would dancers.

While pursuing as a Master's student techniques related to '3D Audio' technologies, he realized that this method would simply not work in an uncontrolled acoustic environment - if the listener moved out of the small 'sweet spot', the illusion would vanish, and there were no practical remedies to this problem, so long as traditional loudspeakers were used. The solution, then, was to not rely on psychoacoustic illusions, but instead to create sound independently of the loudspeaker. One of several ideas he had at the time was the use of interacting ultrasound beams to produce audible sound.

After briefly researching the idea, he discovered the numerous papers describing the underwater parametric array and the earlier attempts of its application as an audible sound source. From these papers, he saw that there were two key concepts which were overlooked in the previous attempts, mitigating their success:

Preprocessing

Earlier attempts used simple AM modulation to generate the ultrasound signal, which does create audible byproducts, but also substantial distortion. The nonlinear transformation from ultrasound to audible sound is much more complex than AM

Lowest-order preprocessing method, used in the earliest MIT prototypes, was derived from a simple model [5] proposed in 1965.

Transducer Design

The transducers used in previous attempts were common piezoelectric transducers used for ultrasonic ranging. These transducers are highly resonant, and do not have sufficient bandwidth to reliably reproduce the preprocessed ultrasonic signal. Thus, even with a preprocessing algorithm, substantial distortion would continue to result until we developed transducers capable of reliably reproducing the broadband preprocessed signal.

As a side project during his Master's work, he continued his development of these ideas, studying nonlinear wave interactions and ultrasonic transducer design, eventually deciding to pursue the area as the focus of a doctoral dissertation. Of all the universities that he applied to, he decided that the free-wheeling nature of the MIT Media Lab was the ideal environment for developing the idea.

The first full size prototype was demonstrated in April 1998 to our Media Lab Sponsors, and performed beyond all expectations. The first demonstration was a John Coltrane solo, whose saxophone was heard loud and clear, projected like a spotlight all around a movie theater, and flying right over the audience. Power consumption was nominal (<30W),

A paper [6] describing the results of the first prototype, as well as a live demonstration, were presented at the 105th Convention of the Audio Engineering Society in September, 1998, and received a standing ovation. While the parametric array itself is not patentable, MIT has applied for patents on key aspects of the technology which make it a practical device.

This directivity plot of a prototype clearly illustrates the extreme narrowness of the beam. (Published in [6]). During the summer of 1998, we compared distortion of prior devices with our prototype. Note that distortion has been reduced nearly to that of a traditional loudspeaker. (Published in [6]).

Since then, development has been remarkably productive, with engineering and mathematical advances resulting in more sound output, better sound quality, and reliable performance.

"Everything you do with light, you can now do with sound."™

References:

- [1] Westervelt, P. J., J. Acoust. Soc. America, v35 535-537 (1963)*
 - [2] Bennett, M. B., and Blackstock, D. T., J. Acoust. Soc. America, v57, 562-568 (1975)*
 - [3] Yoneyama, M., et al., J. Acoust. Soc. America, v73,*
-

[5] *Berkday, H. O., J. Sound Vib., v2, 435-461 (1965)*

[6] *Pompei, F. J., J. Audio Eng. Soc., v47, 726-731 (1999)*

(originally in Proc. 105th AES Conv., Preprint 4853 (1998))

About the Inventor:

Beginning his career in acoustics at 16 while in high school, starting as the first high school co-op and becoming the youngest engineer at Bose Corporation, Frank Joseph Pompei continued working part-time and summers for Bose while earning a degree in Electrical Engineering with an Electronic Arts Minor from Rensselaer Polytechnic Institute. Recognizing the importance and underutilization of spatialized sound, he decided to pursue research in psychoacoustics and application of auditory localization at Northwestern University, earning a Master's degree. Acutely aware of the limitations of traditional loudspeakers, he had the idea of using ultrasound as an acoustic projector, and is now developing such a device at the MIT Media Lab, continuing his education in pursuit of a Ph.D.

Mr. Pompei is honored to have been chosen as a British Telecom fellow for his second year in a row.

For More Information:

A technical paper [6] describing the basic device (along with a live demo) was presented at the Audio Engineering Society's 105th Convention (September, 1998). Please contact them

"Official" press/public inquiries: Contact our Communications and Sponsor Relations team.

Or, you can email me.

All content (c) 1999 F. Joseph Pompei, MIT Media Lab, except where noted. B&W photo of early parametric array (c) 1983 Acoustical Society of America. Reproduction, archiving, and/or redistribution of any part of this document prohibited without written permission from Mr. Pompei or the MIT Media Lab. Patents Pending.

[Up to Contents](#)

APPENDIX TWR1 - THE LADS DEVICE

Tuesday, September 09, 1997 10:20:09 AM

*VSE CORP. LIFE ASSESMENT DECTECTOR SYSTEM (LADS)
Patent Pending*

The Life Assessment Detector System (LADS), a microwave Doppler movement measuring device, can detect human body surface motion, including heartbeat and respiration, at ranges up to 135 feet (41.15 meters). The primary function of the LADS is to provide a reliable method by which medical and emergency personnel can locate personnel buried in building collapses or injured on the military battlefield.

LADS can detect such signs of life as movement, heartbeat, or

available at the <http://www.vsecorp.com> web site. What it showed was mainly a small dish antenna mounted on the top of a tripod. (August 9, 1998)

Originally designed to detect heartbeat and respiration of military personnel wearing chemical-biological warfare protective overgarments, the LADS has been restructured, greatly increasing its operational range and providing a means for eliminating "nuisance alarms" which could mimic human life signs, such as fans, wind drafts, or swaying trees. This is accomplished through neural network technology, which "trains" the system to recognize human motion and heartbeat/respiration functions. If these functions are not detected, the reasonable assumption is that there are no survivors. Operating under such an assumption, the rescue team can now proceed without fear of further loss of life; i.e., rescue and medical personnel and equipment can be deployed more effectively and efficiently.

The LADS consists of a sensor module, a neural network module, and a control/monitor module. The sensor module is an x-band (10 GHz) microwave transceiver with a nominal output power of 15 milliwatts, operating in the continuous wave (CW) mode. The neural network module device can store many complex patterns such as visual waveforms and speech templates, and can easily compare input patterns to previously "trained" or stored patterns.

The control/monitor module provides the LADS' instrument controls, such as on-off switches, circuit breakers, and battery condition, as well as motion, heartbeat waveform, pulse strength, and pulse rate displays.

- Battlefield casualties in a chemical/biological warfare environment;
- Victims of airline, train, or automobile crashes;
- Trapped in an avalanche or mud slide;
- Trapped on a mountain ledge;
- Trapped under a collapsed tent structure; or
- Hostages being held in a nonmetallic room.

For more information about the LADS, send E-mail to:

info@vsecorp.com (1998 info)

[Up to Contents](#)

APPENDIX TWR2 - THE RADAR FLASHLIGHT

Project Title: Radar Flashlight

Project Description:

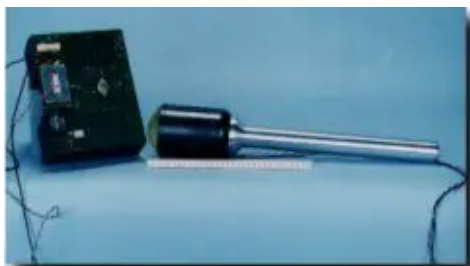

The National Institute of Justice (NIJ), through the Joint (Justice-Defense) Program Steering Group (JPSG), is sponsoring Georgia Tech Research Institute (GTRI) in developing an inexpensive, handheld, low-power radar that will enable law officers to detect individuals through interior building walls. It works by sensing the motion of an individual's chest when they breath.

Status Report:

GTRI is currently designing and refining the first prototype unit. A

and mortar. The Laboratory model shown here, was able to detect individuals through each of these materials. It also demonstrated the ability to detect an individual through the Laboratory's cinder block walls. GTRI is working to combine the two parts of this device into a single unit. NIJ plans on demonstrating the Radar Flashlight with Law enforcement agencies through its National Law Enforcement and Corrections Technology Center (NLECTC) (Southeast Regional Center) before the end of 1999.

Contact:

*Dr. Pete Nacci
Project Manager
Tel: (703) 351-8821*

E-mail: pnacci@darpa.mil

[Up to Contents](#)

APPENDIX TWR3 - MILLIVISION RADAR

Current Millivision information at: <http://www.millivision.com>

PM: TECH UPDATE: Frisking From Afar: OCT 95 Popular Mechanics magazine

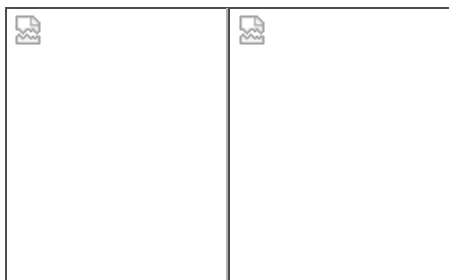

Millimeter-wave camera picks up both metallic and plastic concealed handguns.

DEERFIELD, MA-Between microwave and infrared lies the millimeter wave band. This little-heralded portion of the electromagnetic spectrum turns out to be perfect for "remote frisking." Millitech Corp. has designed a camera to accomplish just that.

[MILLITECH HAS SOLD THE RIGHTS TO MILLIVISION, NORTHAMPTON MA]

The idea calls for measuring the time delay and intensity of millimeter wave energy that radiates naturally. At millimeter wavelengths, people are good emitters, while metals are very poor. Dielectric objects, such as plastics, ceramics and powdered drugs, are somewhere in between. Clothing and building materials, such as wallboard, are virtually transparent.

[Up to Contents](#)

*TWR4.....GROUND [**OR HOME/APT WALL**] PENETRATING RADAR*

THIS IS TEXT EXCERPTED FROM GROUND-PENETRATING RADAR MANUFACTURER PATRIOT SCIENTIFIC CORPORATION. THE PURPOSE OF INCORPORATING THIS TEXT IS THAT GROUND-PENETRATING RADAR SYSTEMS OVERCOME THE PARTLY-CONDUCTIVE-WALL BARRIER TO PASSIVE MILLIMETER WAVE THRU-WALL RADAR.

The original link for this text (as of March 22, 2000) is:

<http://www.ptsc.com/radar/index.html>

technologies with a wide range of possible applications.

This description below will highlight possibilities for use in:

- *Ground Penetrating Radar (GPR)*
- *Communications*
- *Surveillance*
- *Ordnance Detection*
- *Stealth Radar*

The Demonstration System:

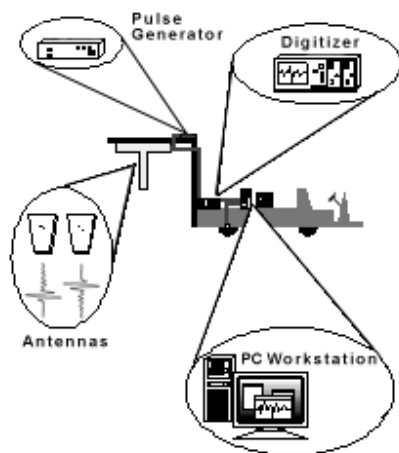

...is a diagram of the demonstration system. A pulse generator is used to drive the transmit antenna. The pulse is a positive spike going up to 100V then falling back to ground in one and a half nanoseconds corresponding to a pulse transmit frequency of 750 MHz.

The return signal is read by the receive antenna. At this point some simple analog processing is done and the signal is digitized at a resolution of 6 GHz, and sent to a PC.

The PC converts the data into a conventional wave form. The

The Pentium workstation is used to apply different digital filters, combine waveforms, and display the results. This system can be used to demonstrate detection of small targets buried in sand, people behind walls, and other targets.

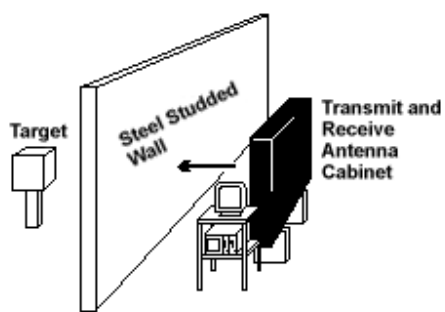

Patriot has used its antenna system to demonstrate detection of objects as small as a coke can buried in sand, through a wall. Even small targets disturb the wavefront of the pulse, producing reflections and modifying the field in measurable ways.

Patriot will be testing this technology for suitability for mine detection. We will be acquiring sample casings and running further tests.

Advantages of Patriot's Impulse Radar System



The key to Patriot's Radar system is its ability to transmit and receive pulses barely longer than single cycles at the transmit frequency. The first waveform shown here is a pulse generated by an earlier Patriot Design, based on "off the shelf" antenna technology. The waveform on the bottom was produced and received by Patriot's current Design.

The current Patriot antenna system produces a pulse at the desired frequency with little leading or trailing noise. The Patriot antenna system provides many advantages over pulse-based systems.

Patriot originally developed the impulse radar system to allow time domain processing in Patriot's GPR systems. Because the impulse is extremely short (3 nanoseconds), the time to return can be used to gauge the distance traveled by the pulse.

Furthermore, the transmit and receive antenna's are very directional, eliminating much of the multipath components of the return signal.

The short pulse combined with the directional transmit and receive to provide us with a number of important advantages:

- Very low average power during transmission*
- Low interference from other transmitters*
- Transmission invisible to conventional receivers*
- High bandwidth digital data transmission possible*
- Difficult detection by other impulse receivers*

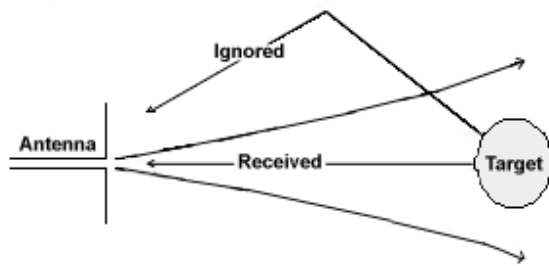

Interference with other sources and receivers is further reduced by using directional antennas. The antenna design shown is highly directional.

When penetrating the ground, we wish to eliminate as much of the multipath signal as possible. The directional antennas reduce the multipath signals detected to those that are relatively inline with the wave path, and eliminate much of the multipath signal that returns at odd angles.

Impulse radar uses low power inherently because the transmissions occur in pulses separated by periods of no transmission. The power of the pulses is offset by the dead time between the pulses. The average output of the current system is about 300 MICROWatts. THE LOW AVERAGE POWER OF AN IMPULSE SYSTEM EFFECTIVELY HIDES THE TRANSMISSIONS FROM CONVENTIONAL RECEIVERS.

Interference can be further reduced in an impulse system by using random interval spacing. As long as the transmit and receive antennas are in sync, the period between pulses can be varied to prevent aliasing with other continuous- or pulse-transmission systems that might be operating in the same locale. Furthermore, if an impulse system is being used to

Scientific's current GPR system does not use random interval spacing.

[Up to Contents](#)

APPENDIX TR1 - COMMERCIAL THOUGHT READING DEVICES

.....

*<http://www.mindmouse.com/> The CyberLink Mind Mouse:
Hands-Free, Brain-Wave Control for your Computer*

The CyberLink Mind Mouse

What is it?

The CyberLink Mind Mouse is a revolutionary hands-free computer controller which allows you to move and click a mouse cursor, play video games, create music, and control external devices, all without using your hands.

How does it work?

A headband with three sensors detects electrical signals on the forehead resulting from subtle facial muscle, eye, and brain activity. This headband connects to an interface box which amplifies and digitizes the forehead signals and sends them to your computer. The CyberLink software decodes the forehead signals into ten BrainFingers for continuous cursor control. It also decodes eye motion and facial gestures into

functions.

I can do what...?

*By Learning to change the energy Levels of your BrainFingers,
you will be able to do just about anything on a computer,
except turn it on! The Cyberlink Mind Mouse supports
hands-free mouse, keyboard and joystick cursor control,
switch closure, video game control, and music and art
synthesis.*

...and it works with my software?

*The Cyberlink Mind Mouse features a Windows 95 Mouse Driver
for hands-free control of third party software like games,
business software, Internet browsers, and a range of
assistive technologies, such as the X-10 Home Controller and
special needs word- processing and communication software,
including WiVik2, Words Plus, and Clicker Plus.*

What kind of computer does it take?

The Cyberlink Mind Mouse has the following PC requirements:

Pentium Processor

16 MB RAM

20 MB Disk Space

VGA or better Display

Windows 95

The CyberLink Mind Mouse consists of the following components:

CyberLink Interface Unit

CyberLink Headband/Sensor Harness with 3 Sensors

Cybergel

Cyber Trainer Software

Windows 95 "Mouse" Driver

Cables

User manual

How much is it?

The CyberLink Mind Mouse is priced at \$1495.00 (US\$) plus shipping. Free upgrades are included for one year.

.....

The Times, Sept 2, 1996 p14 (1)

Title:the power of thought (innovations for paraplegics)

Author: anjana ahuja

abstract:

Peter Gannicott, 36 yr old UK paraplegic who cannot speak , as a result of a motorcycle accident in 1982 , might be able to activate his computer and other devices by thinking if neurosurgery is successful. London university's Emeritus Professor of Physiology, giles Brindley, ad the Radcliffe's Hospital 's chief neurosurgeon, Peter Teddy, have conceived a way whereby signals produced by electrodes over the brain

SIGHTINGS

Implants Can Now Allow Humans To Control Computers

By Nigel Hawkes

Science Editor

The Times (London)

www.the-times.co.uk

AN AMERICAN scientist has entered the world of science fiction by implanting electrodes in the brains of disabled people so that they can control a computer by the power of thought.

The implants have enabled two paralysed people to move the cursor on the screen simply by thinking about moving part of their body. They were able to convey messages such as "I'm thirsty" or "please turn off the light" by pointing the cursor at different icons.

The hope is that eventually patients will be able to communicate complex ideas just by thinking about them. "If you can run a computer, you can talk to the world," Dr Ray Bakay of Emory University in Atlanta, whose team developed the implants, said.

A number of laboratories around the world are working on brain implants, but the only devices licensed for use so far are bionic ears for the profoundly deaf and chips which can control the tremor caused by Parkinson's disease.

placed into the brain's motor cortex, which controls body movements. The cones are covered in chemicals that encourage nerve growth, extracted from the patient's knees. Once installed, nerve cells grow into the cones and attach themselves to tiny electrodes inside.

The location of each cone is determined by monitoring the patient's brain using scanners and identifying the most active regions. Once the cones are in place and surrounded by nerve cells, the patient is asked to think about moving some part of the body, and signals from the electrodes are picked up by a small transmitter-receiver, amplified, and used to control a computer. Depending upon which nerves grow into the cones, each patient may have to think about moving a different part of the body to achieve the same effect.

They are trained by listening to a buzzer which becomes faster and louder when they are thinking along the right lines. Dr Bakay says that controlling the cursor soon becomes second nature.

The first two patients, New Scientist reports, were a woman with motor neuron disease, who was given the implants 18 months ago and has since died, and a 57-year-old man paralysed by a stroke.

They were taught very simple commands, with one cone being used to move the cursor up and down and the other from left to right. If they could give more complex commands, disabled

continue the research with three more patients.

The British Telecom Laboratories near Ipswich have also done research into implantable chips, including a possible memory chip which would take data from the eye and store it for a computer. "There is a raft of wonderful benefits to bringing chips and circuits inside human beings," said Dr Peter Cochrane, head of research.

.....

Communicating with 'thought power'

"Bionic brain implants allowing a computer to be operated by the power of thought, have been developed by American scientists," reports BBC News. Read all about it here:

http://www.news.bbc.co.uk/hi/english/sci/tech/newsid_193000/193946.stm

The BBC report states that "the [brain] implant becomes naturally 'wired' into the patient's brain as neurones grow into the cones and attach themselves to the electrodes mounted inside," and that "An FM transmitter under the scalp transmits the signal without wires, and...no batteries," to operate the cursor on a computer... hard to believe!

[Up to Contents](#)

APPENDIX TR2 - RATS CONTROL DEVICES WITH THOUGHT

CLASSIFIED technology is always a decade or two ahead of the unclassified world, imagine what exists now in the black areas of defense contractors and government labs!]

Rats Control Robot by Thought Alone

By Maggie Fox

Reuters

WASHINGTON (June 23) - It sounds like something out of science fiction -- a rat with a small electrode sticking out of its head decides it wants a drink and, without touching anything at all, gets a robotic arm to bring it some water.

Still, a team of neurobiologists say their rats can control a machine with brainpower alone, and they think their technology may someday help paralyzed people.

'The people in the lab started calling the experiment the 'thinking about drinking experiment,' John Chapin of Hahnemann Medical College in Philadelphia, who led the research, said in a telephone interview. 'But we don't know whether rats think.'

Whatever the rats are doing, they are controlling the robotic arm without touching anything, said Chapin, who worked with colleagues at Duke University in North Carolina.

Reporting in the July issue of the journal Nature Neuroscience, they said they implanted tiny electrodes, no thicker than a hair,

little plug coming out of the animal's head. He runs around the cage and everything.'

The electrode is recording the activity of neurons -- on average 46 -- which Chapin found was important to making the experiment work. Earlier studies that recorded the activity of just one or a few brain cells did not work.

'We trained the rat initially to put his paw on a lever and to press the lever down. When the lever got pressed down there was a robot arm that moved over to a water dropper and then brought the water back to the animal's mouth,' Chapin said.

The rats had to carefully control the lever -- if they only pushed the lever halfway, it would only bring the arm halfway to them.

Chapin's team then recorded the brain activity associated with the movement of pressing the lever.

'We have an electronic device that converted those patterns of activity in the brain of the animal into a single electronic signal that could move the robot arm,' Chapin said.

Soon they disconnected the lever from the robot arm and hooked it up to the converting device alone.

They found, as other researchers have, that the brain activity controlling the movement came before the actual movement.

'After a couple of days, the animals began to recognize that and they stopped actually pressing the lever.'

Chapin said if the technique can be proven safe and reliable in animals such as monkeys, which have bigger and more complex brains than rats, it might eventually be tested in people with severe paralysis.

'If this really becomes a workable thing, I think there are a lot of people that could use it,' he said.

It is important to record the signals from many neurons and not just a few, Chapin said. Of the six rats tested, he added, just four could get the arm to work. 'Two rats would do it a few times and then they would stop,' he said.

'The reason was we were not recording enough neurons in those animals. The robot arm would jerk around a lot and it wasn't smooth. When the animal tried to get his mouth around it, it would kind of bop him on the nose. They didn't like it.'

For complex movements, such as those made by an artificial limb, even more neurons will be required, he said.

'In principle, it should be possible to tap this information and control a prosthetic limb,' Dr. Eberhard Fetz of the University of Washington in Seattle wrote in a commentary on the findings.

APPENDIX TR3 - THOUGHT READING BY RADIO SIGNAL

ELCTRONICS & BRAIN CONTROL

Excerpted From

Popular Electronics Magazine

July 1973, Vol. 4, Number 1

by L. George Lawrence

Comments by Eleanor White: This article is excerpted mainly to provide experimenters and researchers with leads toward much better quality evidence that electronic mind control works. This article is NOT rigorously enough referenced that it will stand as evidence by itself.

Only those paragraphs which are of high relevancy have been transcribed; the article is long and since it is not a courtroom-ready document, I won't be adding to this transcription.

Items in square brackets [] are comments inserted by me to clarify the original text.

[pg 65]

It is time that we closely examined brain control now that scientists are actively seeking to unravel the mysteries that shroud that miniature bioelectric giant known as the human brain. Elements of brain control can already be found in anti-collision radar technology involving birds.

[See Allan Frey's paper](#)

[SNIP]

[pg 66]

It was during these [Frey] studies that a profoundly important discovery was made: Deaf subjects often had the ability to hear radio frequency sound. The clinical criterion was that, if a given person could hear audio above 5 kHz [higher range of a piano] by bone or air conduction, then radio frequency sound could be heard as well.

This and related work has resulted in the manufacture of radio frequency [!!] type hearing aids for the deaf, one of which is made by LISTENING INC., 6 Garden Street, Arlington, Mass., and is known as the Neurophone Model GPF-1. [Not FLanagan's Neurophone] It operates at 100 kHz [about five times the normal maximum hearing frequency] and employs crystal control.

[pg 67]

These observations tie in with the fact that some individuals can detect radio programs through fillings in their teeth. This phenomenon was technically verified by interposing shields between respective people who exhibited this effect and the modulated radio frequency sources.

["Modulation" means "changes" made to an otherwise steady signal.]

When the lower half of the head was covered, including the maxillary

the result of *DIRECT* cortical stimulation.

[In other words, even when the sound seems to be coming from the teeth, it is actually being directly received and interpreted in the brain, not the teeth.]

[SNIP]

[pg 68]

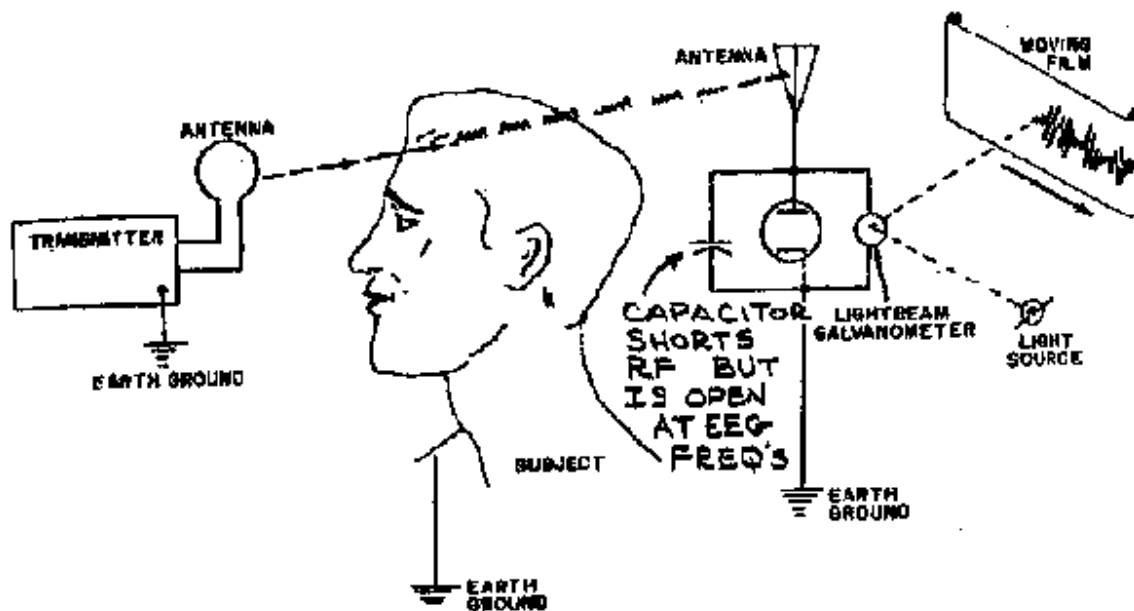

Fig. 4. Cazzamalli's brain-wave detector of some years ago is illustrated here.

Brain-Wave Detection. Some 40-odd years ago, university professor F. Cazzamalli started publishing papers on the subject of brain-wave detection [using radio signals] and implied that he had detected radiations from the mind. [See image above.]

recorded "beat frequencies" obtained with an untuned receiver consisting of a galena crystal or diode tube [same thing for practical purposes], a fixed capacitor, an antenna, and a sensitive light beam galvanometer. [A "galvanometer" is a voltmeter; light beam types show up in physics labs and are one of the most sensitive types of voltmeter.]

The trouble is that Cazzamalli never mentioned transmitter power in his somewhat unprofessional papers [that's why we can't use this experiment directly as standalone evidence]. His oscillograms meant to show variations of the "beat" when his subjects were emotionally aroused or engaged in creative tasks when they were in the Faraday cage. ["Beat" as used by Cazzamalli refers to EEG-frequency, i.e. ELF, traces.]

Later he told an astounded world that his subjects would hallucinate when under the influence of his "oscillatori telegrafica", it's frequency being around 300 MHz at the time. [Aviation radios are in this range.]

Tom Jaski, a noted science writer and engineer duplicated some of Cazzamalli's work with a modern low-power oscillator that was swept from 300 MHz to 600 MHz. [Cell phones start at over 900 MHz.]

His subjects could not see the dial. They were told to sound off as soon as they felt something unusual. At a certain frequency range - varying between 380 MHz adn 500 MHz - the subjects repeatedly indicated points with exact accuracy in as many as 14 out of 15 trials. At these "individual" ...

[pg 69]

alligator!]

The oscillator's output power was only a few milliwatts, while the oscillator itself was located several feet away from the subjects.

[Any experimenters out there want to try this? Milliwatts are quite safe for short term experiments. Kids' walkie talkies are 50 to 100 milliwatts, for example.]

[SNIP]

[Up to Contents](#)

APPENDIX TR4 - ELECTRONICS SEES WHAT A CAT SEES

Eye's Visions Electronically Read And Displayed

Eleanor White's comments: Over decades of experience and among around 300 involuntary neuro-electromagnetic experimentees, there have been instances where two types of thought reading were evidently performed by the experimenters:

- Electronic reading of thoughts "said to one's self"*
- Electronic viewing through the eyes of the experimentee*

This article is about picking up recognizable images from a living brain (a cat's) and displaying those images on a screen. Keeping in mind that classified projects can be 20 or more years ahead of unclassified work (e.g. the SR-71 aircraft), the claims of the

*(** NOTE: While pondering the technology here, the reader should also reflect on the apparent ease with which these experimenters can cut up a cat's skull, restrain it, in obvious discomfort and extreme unwillingness, to obtain this data. We 300 victims would like to point this out to show the world that this same callous attitude is what enables similar covert experimenters to torture us around the clock and completely shatter our lives.)*

.....

WIRED MAGAZINE

Issue 7.10 Subscribe to Wired.

A Cat's Eye Marvel

by Leander Kahney

3:00 a.m. 7.Oct.99.PDT

In a dramatic demonstration of mind reading, neuroscientists have created videos of what a cat sees by using electrodes implanted in the animal's brain. Garrett Stanley of Harvard, and Fei Li and Yang Dan of the University of California, Berkeley, were able to reconstruct in startling detail scenes flashed before a cat's eyes.

.....

Read ongoing Med-Tech coverage

.....

The reconstructed scenes clearly demonstrate the scientist's ability to decode the language of the cat's visual system.

Having recorded patterns of firing as various scenes were flashed before the cat's eyes, the team was able to reconstruct very closely what the animal saw, which varied from people's faces to scenes of a dark forest.

The research was applauded by other neuroscientists.

"The demonstration that you can reconstruct a movie from the multiple cells in the thalamus is an important step in our understanding of how signals are represented in the activity of populations of cells," said Fred Rieke, an assistant professor of physiology and biophysics at the University of Washington.

Stanley, an assistant professor of biomedical engineering, said the research provides clues about how prosthetics may one day be wired into the mammalian nervous system. By understanding the language of the brain, scientists will be able to create devices that talk to it, he said.

"Trying to understand how the brain codes information leads to the possibility of replacing parts of the nervous system with an artificial device," he said.

Stanley predicted that in the next couple of decades, as more and more of the neural code is decoded, brain interfaces may start to appear.

But he cautioned it may take a lot longer. He noted that the team

"So little is understood about thoughts, perceptions, dreams, it's impossible to predict how much progress we'll make in understanding them," he said.

However, Ken Miller, as associate professor at the University of California, San Francisco, said researchers around the world are using similar techniques to decode higher brain functions.

"These methods could be applied to further up the visual pathway," he said. "It will become more difficult ... but it's a promising direction."

The experiments were reported in the September 99 issue of the Journal of Neuroscience.

.....

BTW--the images they saw are posted

You can see the images here:

http://jase.deadbeets.com/recon_figure2.html

.....

[Up to Contents](#)

TR5.....MIND SWITCH - THINK APPLIANCES ON, OFF, OR ADJUST

Original Link (March 2000):



The Mind Switch refers to the technology that has been developed which allows a person to turn on and off an electrical appliance, such as a desk lamp or TV in 2-3 seconds using EEG signals, without training. Proportional control, such as turning up or down the volume of a radio is also possible with the technology. This research is being carried at the University of Technology, Sydney (UTS).

BACKGROUND - General

Early in 1994 while studying the response of the brain to environmental factors Professor Ashley Craig and Mr Paul McIsaac of the Department of Health Sciences at UTS, noticed an effect which appears to be common among all persons. That effect is an increase in a particular brain signal when a person closes his/her eyes for more than one second. The important question that Ashley and Paul then asked was could this effect be used to do something useful?, ie - could the control of the brain signal be used, in turn, to control something else?

At this stage Ashley contacted Professor Tony Moon, the Dean of Science at UTS, to find out if anyone could help answer the technical questions and design a system that might exploit the apparent change in the signal level when a person closes his/her eyes. Professor Moon introduced Ashley to Assoc Prof Les Kirkup who is a associate professor in the department of

It was thought he could offer important input to the project. He was initially sceptical that signals as small as those that are present on the scalp, (where electrodes are placed to pick up brain activity) could be detected reliably and analysed sufficiently quickly to allow activation of an external device, such as a Lamp or TV. The data that had been gathered on signal levels with eyes open and eyes closed showed that a significant increase occurred in the 8-13Hz part of the 'brain spectrum' commonly referred to as the 'alpha' region.

Les built a detection, discrimination and analysis system based on Ashley and Paul's data and, much to his surprise at least, the first person (Lucy) connected to the system showed the capability of operating a switch which could control an electrical appliance.

BACKGROUND - Technical

Serious work done on brain signals began with Berger in 1929 [Berger 1967]. Since that time the acquisition and analysis of brain signals, referred to as Electroencephalography (EEG) has advanced to such a state that EEG is regularly used to assist in the diagnosis of schizophrenia, epilepsy and brain tumours. [Geddes and Baker, 1989]. EEG has also been used in biofeedback studies in which subjects may learn to modify their EEG signals in response to visual representation of their EEG signals.

person to close his/her eyes for more than 1 second to effect sufficient change in the signals levels to allow for the reliable operation of a switch. It turns out that it has been known for many years that increase in signal level occur upon eye closure, but this is the first example (to our knowledge) of the recognition of its potential and the exploitation of the effect.

The system used to detect the change in signals consists of amplifiers, filters and other signal processing elements (FULL DETAILS ARE STILL CLASSIFIED at the moment!). As there are other sources which can generate signals which can interfere with brain signals (and hence cause intermittent switching on and off of appliances) we have developed a noise suppression system which eliminates the effect of those noise sources. This feature is very important as we are currently developing the technology for disabled persons (we have a three year grant from the Motor Accident Authority of New South Wales, MAA) and reliability is a major issue. The funding from MAA has allowed us to appoint Mr Andrew Searle who has become a key figure in the technical developments regarding the Mind Switch.

In addition Mr Perez Moses is developing new noise suppression techniques to be applied in this work.

Berger, H. 1967. On the electroencephalogram of man (trans. by P. Gloor). EEG Clin. Neurophysiol., Suppl. 28:1-350

[Up to Contents](#)

APPENDIX IMP1 - PROMOTION OF HUMAN IMPLANTATION BY NIH

THIS TEXT WAS COPIED FROM THE ORIGINAL NIH/CNCT WEB SITE AT THIS ADDRESS:

<http://www.engin.umich.edu/center/cnct/orgind.html>

Center for Neural Communication Technology Organization

The NIH NCRR requires that its Centers have several basic components: internal research projects, collaborative research projects, and service to external investigators in the form of distribution and training. The organization of the Center for Neural Communication Technology (CNCT) will be described here with links to more details on individual projects.

The underlying goal for all of the work conducted by the CNCT is to make multichannel recording and stimulation devices available to researchers which will enable them to more efficiently communicate with the brain. Micromachined electrodes offer the potential to extend small ensemble studies to tissue volume studies consisting of dozens if not hundreds of cells.

Internal Research Projects

There are three internal research projects under the Center which are

Extend the basic structure of the device to include fluid carrying channels for delivery of fluids to tissue volume, and/or to lesion at recording/stimulation site locations.

Project 2, Biological Neural Networks:

Develop techniques for data acquisition from and analysis of neural circuits in the volume surrounding arrays of recording devices. The direction which has been proposed for this project over the next grant period will be to study the relationships between the physical characteristics of the devices and the architecture of the neural tissue to rationalize the process of design and experimentally explore and model the deterioration of chronic implants over time to improve their behavior. A recent poster presentation on data collected from the cochlear nucleus can be seen [on the original site.]

Project 3, Morphological Visualization and Assessment:

Explore the envelope of tissue surrounding stimulation, recording and/or chemical delivery probes for histological evidence of deterioration of probe performance which has been observed electrophysiologically in vivo.

Collaborative Research Projects

In addition to internal projects, there are multiple collaborative research projects with investigators outside the Center.

Collaborators contribute significantly toward improving and expanding

protocols for chronic electrode site maintenance, testing of advanced devices, and exploration of new application areas.

Here are links to webpages of some of our collaborators (more to come.....):

<http://osiris.rutgers.edu/Buzsaki.html>

Gyorgy Buzsaki, M.D., Ph.D., Rutgers University, Neural network activity in the hippocampal formation

<http://www.dbbs.wustl.edu/RIB/Highstein.html>

Steven Highstein, M.D. Ph.D., Washington University, Effects of microgravity upon the labyrinth

http://msewww.engin.umich.edu/people/milTy/protein_polymers.html

David Martin, Ph.D., University of Michigan, Microstructure and processing of bioactive protein polymers

<http://www.med.umich.edu/khri/censys/jmiddleb.htm>

John Middlebrooks, Ph.D., University of Michigan, Cortical representation of auditory space

Service to investigators outside of the CNCT is provided in the forms of distribution of probes, and training in their use.

Distribution has been a key component of the CNCT since its inception. In fact, it provided the main motivation for applying for

catalog. Standard devices are provided packaged appropriate for acute use. Prior to receiving additional batches of probes, we require the submission of a feedback form so that we may track progress and use the data to better understand and improve the technology.

The CNCT offers several training opportunities to provide education and experience in the design, handling and application of multichannel probes.

[Up to Contents](#)

APPENDIX IMP2 - ITALIAN DOCTOR REPORTS HUMAN IMPLANTATION

July 1999 Statement by an Italian Doctor Regarding Unusual Human Implants

This physician has requested anonymity but is well-known to the involuntary human experimentation community and can be contacted through some of us. Eleanor White

..... statement by Italian physician

"A physician of my acquaintance has repeatedly discovered metal objects implanted into a number of residents - normal people, workers - of small towns in the North-Western surroundings of Turin, towards the valley ending in the French frontier.

"These devices, to the best of my knowledge, are not for any therapeutic purpose. Knowing that people have been used for involuntary electronic implantation experiments, these patients may have also been implanted in

[Up to Contents](#)

APPENDIX IMP3 - IMPLANT TRANSMITS PHYSIO- AND PSYCHO- PARAMETERS BY RADIO

Unclassified Read-by-Radio Implant Development Project

Eleanor White's comments on this posting: This posting describes unclassified wireless telemetry of bodily functions, used for benign and beneficial purposes. This is about monitoring BY RADIO.

The reason it is of interest to involuntary neuro-electromagnetic experimentees (military and intelligence) is that development programmes like this one show that both the WILL and the MEANS to track someone's bodily functions by radio EXIST, and exist RIGHT NOW.

People seeking to discredit us will say that such technology could not possibly be in use now, or in some cases, even exist. Keeping in mind the typical 20-year spread between classified and unclassified technology, as demonstrated by the SR-71 reconnaissance aircraft, it is clear that classified military and intelligence programmes have highly advanced methods of tracking a target's body functions.

.....
PROGRAM; SBIR (Small Business Initiative Research)

AGENCY; AF

FIELD OFFICE; AL

TOPIC NUMBER; AF93-023

CONTROL NUMBER; 93AL-226

CONTRACT NUMBER; F41624-93-C-2005

AWARD COMPLETION DATE; 11DEC93

PROPOSAL TITLE; TELEKTRODE SYSTEMS FOR UNOBSTRUSIVE
BIOPOTENTIAL RECORDING

PRINCIPAL INVESTIGATOR NAME; RICHARD L. HORST, PhD

PRINCIPAL INVESTIGATOR PHONE; 301-596-4915

FIRM; MAN-MADE SYSTEMS CORP

4020 ARJAY CIRCLE

ELICOTT CITY, MD 21042

WOMAN OWNED; N

MINORITY OWNED; N

NUMBER OF EMPLOYEES; 6

.....

KEYWORDS; BIOTELEMETRY ELECTROPHYSIOLOGY SENSORS

MICRO-CIRCUITRY

ABSTRACT; *Biopotential recordings of human psycho-
physiological parameters are hampered in many field settings,
and some laboratory and clinic settings, by the sensor
technology.*

*[Eleanor White's comment: Take SPECIAL NOTE of that
word "PSYCHO-"... that has great significance for neuro-
electromagnetic experimentees!]*

*Conventional electrodes which tether the subject to the
signal amplification and recording equipment, are cumbersome*

This project seeks to design essentially wireless electrode recording systems that use radio frequency telemetry to transmit the biopotential signal from the recording site to a body-worn transceiver and then to a remotely located receiver.

[Eleanor White's comment: That means, radio signals THROUGH THE FLESH to an externally worn transceiver. The only difference between this UNclassified project and the involuntary neuro-electromagnetic experimentees is distance, which can be overcome with time.]

The present subcontractor has developed transceiver and receiver technology that will be reviewed and customized as needed for the present application. The focus here will be on developing a generic design for the sensor subsystem ("telectrodes") to include the transducer interface with the skin, miniaturized amplifier and filter circuitry, an optimal connection between the transducers providing differential inputs to the amplifier, a longlasting but compact battery, and transmitter.

Phase I will consist of a design specification, development of a bench-top engineering prototype, design trade-off studies using the prototype, and the delineation of a detail design.

References

[2] *"Monitoring the Mysteries of the Fetus", NASA-Ames
Research Center, Videotape 1996.*

[3-10] *Deleted as irrelvant to showing implants are being
actively designed and used. Eleanor White.*

[11] *J.W. Hines, C. J. Soms, et al., "Advanced Biotelemetry
Systems for Space Life Sciences: pH Telemetry", Procs. 13th
Annual International Symposium on Biotelemetry, Williamsburg,
Virginia, March 26-31, 1995, p. 37. 20*

[Up to Contents](#)

APPENDIX IMP4 ... DR DELGADO'S "STIMOCEIVER"/HUMAN IMPLANT EXPERIMENTS

**** THIS IS A BENEFICIAL EXPERIMENT, HOWEVER, *NO MODIFICATIONS* ARE NECESSARY
TO APPLY THIS TECHNOLOGY FOR CRIMINAL PURPOSES AND TORTURE**

PSYCHOTECHNOLOGY

*Electronic Control of Mind and Behavior
edited by Schwitzgebel and Schwitzgebel
published Holt, Rinehart and Winston Inc.
[Each chapter is by a different author]*

Chapter 15

page 184

Intracerebral Radio Stimulation and Recording in Completely Free Patients

Diagnosis and treatment of focal brain dysfunction associated with behavioral abnormalities are complex tasks which require more effective exploratory techniques. Intracerebral electrodes, electrocorticographical studies, and subsequent discrete neurosurgery have given the epileptologist and stereotaxic surgeon new possibilities for clinical investigation which as yet have been applied to only a small percentage of the patients suffering from neurological disorders including temporal-lobe epilepsy and related episodic behavior problems.

In these therapeutic studies, recordings and stimulation of any chosen cerebral structure can be performed over a period of days or weeks, and neuronal sites identified as triggers for abnormal electrical patterns associated with behavioral disturbances can be destroyed by electrolysis or resection.

Unfortunately in some patients episodic behavior disorders may be more disabling than their epileptic seizures, and focal lesions may improve one syndrome without modifying the other. Furthermore, recording and stimulation are usually performed under conditions which qualify their usefulness, because the patients' mobility is limited by connecting leads, and the behavior is likewise altered by the stressful and artificial environment of the recording room.

[Inset] Reprinted from The Journal of Nervous and Mental Disease, copyright [copy unreadable] by the Williams and Wilkins Company, Vol. 147, No. 4. Reproduced by permission.

1 Research and instrumental development fro the construction of the stimoceiver was supported by the United States Air

Office of Naval Research, 609 (48).

The circuit for EEG recording is a modified version of the unit described by Meehan (1965), and his help in providing us with the information and one of his units is gratefully acknowledged. The help of Mr. Per Ha...[unreadable] developing telestimulation is also gratefully acknowledged.

During the last few years, methodology has been developed to stimulate and record the electrical activity of the brain in completely unrestrained monkeys and chimpanzees (Delgado, 1967; Delgado and Mir, in press). This procedure should be of considerable clinical interest because it permits exploration of the brain for unlimited periods without disturbing their rest or normal spontaneous activities. [EW: Dr. Delgado, you are ALL heart!]

This paper reports instrumentation used and clinical application in four patients with psychomotor epilepsy in whom electrodes had been implanted in the temporal lobes. To our knowledge, this is the first use of intercerebral radio stimulation and recording in man.

METHODS

page 185

Implantation of electrodes

Electrodes were constructed and stereotaxically implanted according to methods previously described (Mark & Ervin, 1969). The electrode assemblies which were connected to a McPherson skull plug, consisted of a plastic stylet, 1.2 mm in diameter, with 15 stainless steel ? mm wide contacts at

assemblies were implanted ???laterally into the anterior medial amygdala of each patient.

Radio Stimulation

This system consists of two instruments: (1) the RF transmitter that measures 30 cm x 25 cm x 15 cm and includes the circuitry for controlling repetition rate, duration, and amplitude (intensity) of the stimulating pulse. The repetition rate may be varied in steps between 10 and ?? Hz and the duration between 0.1 and 1.5 millisec. Single pulses may also be generated.

Intensity control is accomplished by varying the frequency of the three subcarrier oscillators that operate in the 100 to ?00 kHz frequency range. A 100 MHz oscillator is turned on and off by the pulse train from the subcarrier oscillators. The duration of this pulse is determined by the pulse-duration switch. These bursts of 100 MHz RF energy are received by (2) the receiver-stimulator which is carried ?? the subject, measures 3.7 cm x 3.0 cm x 1.4 cm, and weighs 20 grams.

The solid-state circuitry is encapsulated in epoxy resin which provides it with very good mechanical strength and makes it waterproof. Space for the ? volt mercury battery is included in the size mentioned above.

After RF detection, the resulting subcarrier frequency is demodulated into an amplitude. This amplitude controls the current intensity of the stimulation pulse by means of a constant current transistor in the output circuit of the receiver. This method makes the pulse intensity independent of biological impedance changes over a wide range. Under average stimu-

[EW: This is prototype equipment, unclassified, and operating sometime in the 1970s. Imagine classified equipment at the end of the 20th century!]

Three channels of stimulation are available. The pulse intensity of each channel can be controlled individually from the transmitter. The pulse duration and repetition rate are the same for all three channels.

Encephalographic (EEG) Telemetry

A miniature FM-FM amplifier-transmitter combination and telemetry receiver are used for this purpose. (1) The transmitting circuitry, carried by the subject, consists of an EEG amplifier with a gain of 100, input impedance of 2 megohms, frequency response from 2 to 200 Hz, and a voltage-controlled oscillator (VCO) for each channel. The VCO operates in one of the frequency bands assigned for subcarrier oscillators by the IRIG standards.

In these studies, a three-channel system was used which operated on IRIG channels (Delgado & Hamlin, 1962; Delgado & Mir, in press; Fonberg and Delgado, 1961). The outputs of all three subcarrier oscillators were summed and connected to the single RF transmitter module.

The miniaturized RF transmitter operates at 216 MHz and its range is 50 to 200 feet, depending on the environment. The size of the three channel unit, including the battery, is 4.5 cm x 4.5 cm x 1.5 cm and it weighs 50 grams.

The signals from the depth electrodes are received by the amplifier. The

(2) After amplification of the received signal from the transmitter has been demodulated, the composit subcarrier signals are connected to the inputs of the three discriminators, which then separate and demodulate their respective subcarriers to obtain the telemetered analog information. In the instrumentation used in this instance, a 100 microvolt signal at the input of EEG amplifier resulted in a 1-volt output from the corresponding discriminator in the receiver.

The analog output signals from the receiver were connected to the inputs of an EEG recorder and a magnetic tape recorder.. A microphone was also mounted in the room with the subjects and conversation was also recorded along with the EEG on magnetic tape.

[EW: So much for the idea that human implantation and MILITARY PARTICIPATION therein is only a myth.]

[Up to Contents](#)

APPENDIX IMP5 ... UNCLASSIFIED SATELLITE TRACKING HUMAN IMPLANT SYSTEM

SIGHTINGS

World's First Satellite-Tracked Human Implant Device

Applied Digital Solutions, Inc.

12-17-99

Eleanor White's comments: This article clearly shows both availability of technology, (the classified world has certainly had this for some time), and intent to produce satellite-based human tracking implants.

.....

PALM BEACH, FLORIDA - Applied Digital Solutions, Inc. today announced that it has acquired the patent rights to a miniature digital transceiver - which it has named "Digital Angel" -- that can be used for a variety of purposes, such as providing a tamper-proof means of identification for enhanced e-business security, locating lost or missing individuals, tracking the location of valuable property and monitoring the medical conditions of at-risk patients.

In the agreement signed last week, ADS acquired the right to develop this unique product itself for all of its applications or to sublicense the development of specific applications to other entities. A special technology group has been formed within ADS to supervise the development of the device.

The implantable transceiver sends and receives data and can be continuously tracked by GPS (Global Positioning Satellite) technology. The transceiver's power supply and actuation system are unlike anything ever created. When implanted within a body, the device is powered electromechanically through the movement of muscles, and it can be activated either by the "wearer" or by the monitoring facility. A novel sensation feedback feature will even allow the wearer to control the device to some degree. The "smart" device is also small enough to be hidden inconspicuously on or within valuable personal belongings and priceless works of art.

Commenting on Digital Angel's many potential applications, Richard J. Sullivan, Chairman and CEO of Applied Digital Solutions, Inc. (ADS),

we expect to come forward with applications in many different areas, from medical monitoring to law enforcement. However, in keeping with our core strengths in the e-business to business arena, we plan to focus our initial development efforts on the growing field of e-commerce security and user ID verification."

Sullivan added that the multi-purpose technology would enable ADS to tap into a vast global market, through licensing and other commercial arrangements, with an estimated total value in excess of \$100 billion. "The e-business to business security market alone could reach as high as \$10 to \$12 billion in the near future," Sullivan added.

ADS is actively seeking joint venture partners to help develop and market the unique technology. The company expects to create a working prototype by the end of next year.

Applied Digital Solutions, Inc. is an e-business to business solutions provider offering Internet, telecom, LAN and software services to a wide variety of businesses throughout North America. For more information, visit the Company's web site at:

<http://www.adsx.com>

[Up to Contents](#)

POSTSCRIPT

Advances in neuroscience 'may threaten human rights'

[Nature Magazine](#) - January 22, 1998

research in human genomics -- may lead to an excessive focus on genetic determinism and raises the spectre of genetic discrimination. This was one of the conclusions to emerge from the annual public meeting of the French national bioethics committee held last week in Paris on the theme of 'Science and Racism'.

Jean-Pierre Changeux, the chairman of the committee and a neuroscientist at the Institut Pasteur in Paris, told the meeting that understanding the working of the human brain is likely to become one of the most ambitious and rich disciplines of the future.

"But neuroscience also poses potential risks", he said, arguing that advances in cerebral imaging make the scope for invasion of privacy immense. Although the equipment needed is still highly specialized, it will become commonplace and capable of being used at a distance, he predicted. That will open the way for abuses such as invasion of personal liberty, control of behaviour and brainwashing. These are far from being science-fiction concerns, said Changeux, and constitute "a serious risk to society".

Denis Le Bihan, a researcher at the French Atomic Energy Commission, told the meeting that the use of imaging techniques has reached the stage where "we can almost read people's thoughts".

The national bioethics committee is taking such threats so seriously that it is launching a study to consider the issues and recommend possible precautions. The study will also cover more immediate issues such as the legal question of whether criminals are responsible for their actions; Changeux predicts an increase in defence arguments

In closing the meeting, Claude Allegre, the minister for national education, research and technology, hinted at the creation of a revamped parliamentary office of technology assessment, arguing that the national bioethics committee's approach in the life sciences needed to be applied to other areas of science.

Declan Butler

Nature; Macmillan Publishers Ltd. 1998

Registered No. 785998 England.

[Up to Contents](#)

=====

[Up to Contents](#)

[ALPHABETICAL Site index page](#)

[SUBJECT Site index page](#)

